

Wood Trick®

WOOD TRICK
LONG VEHICLE

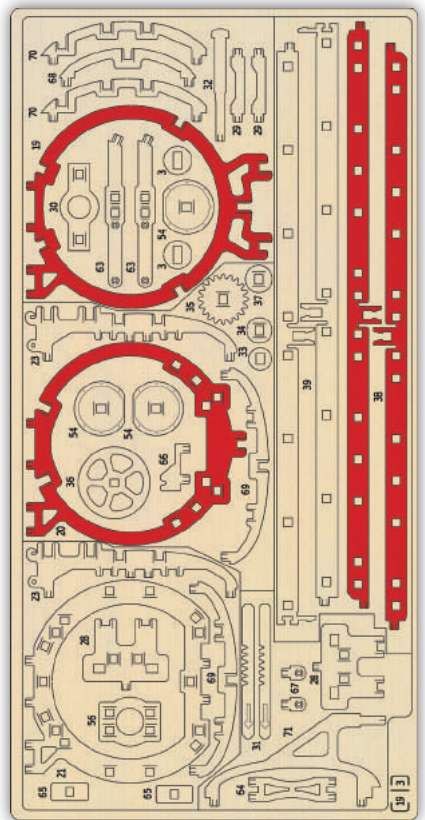

3

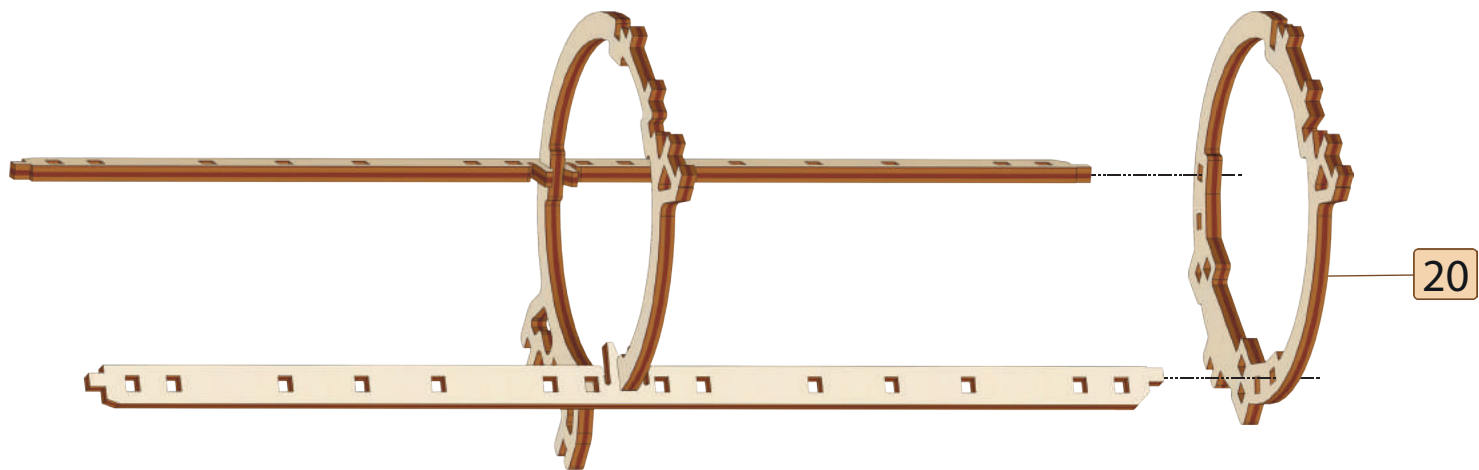
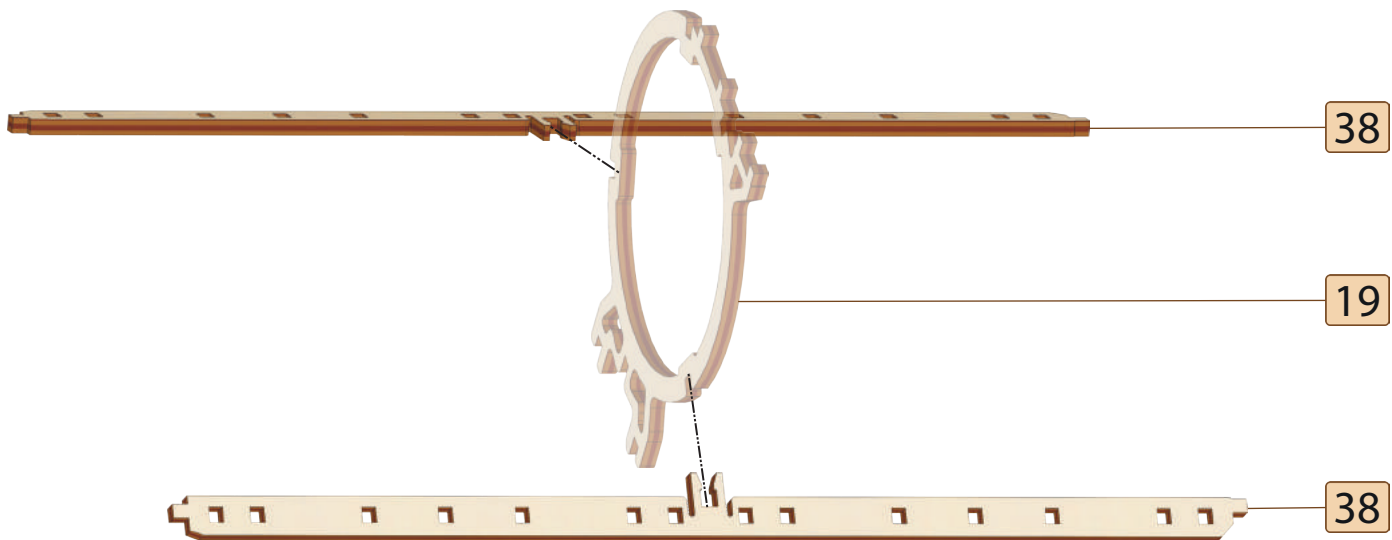

[1]

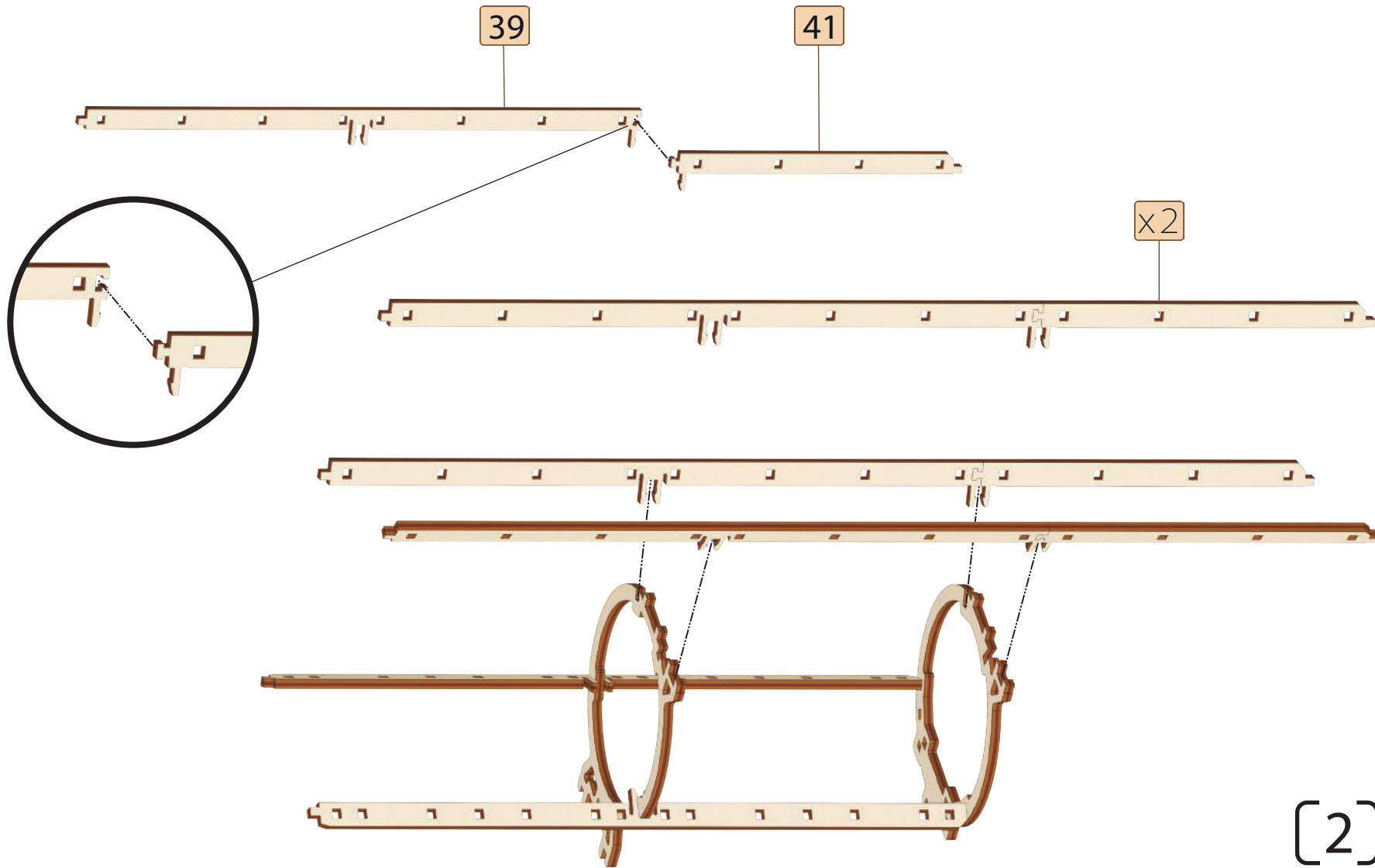
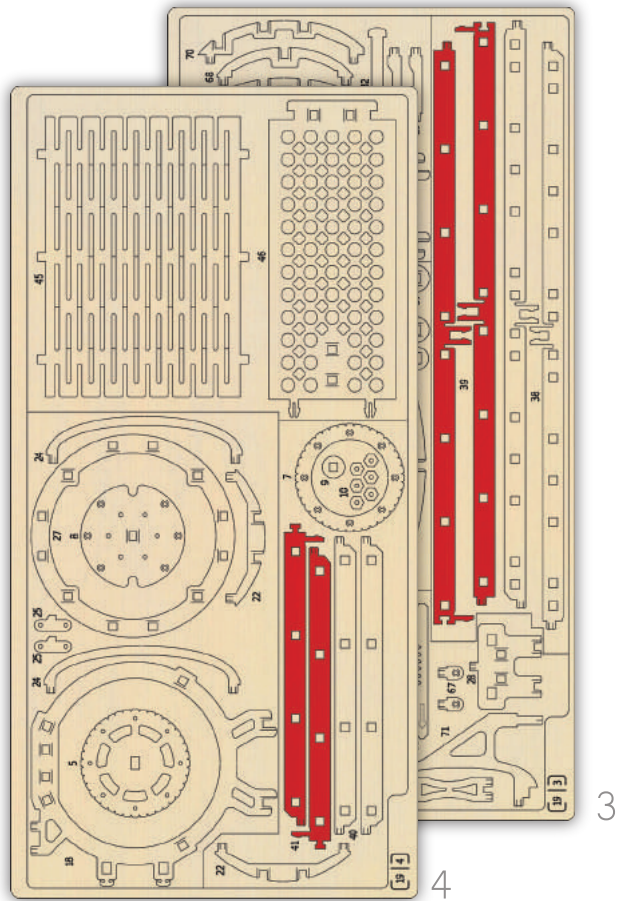

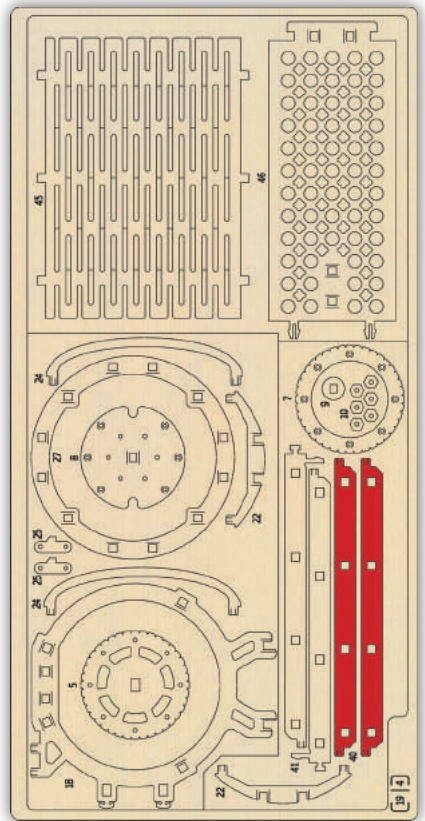

4

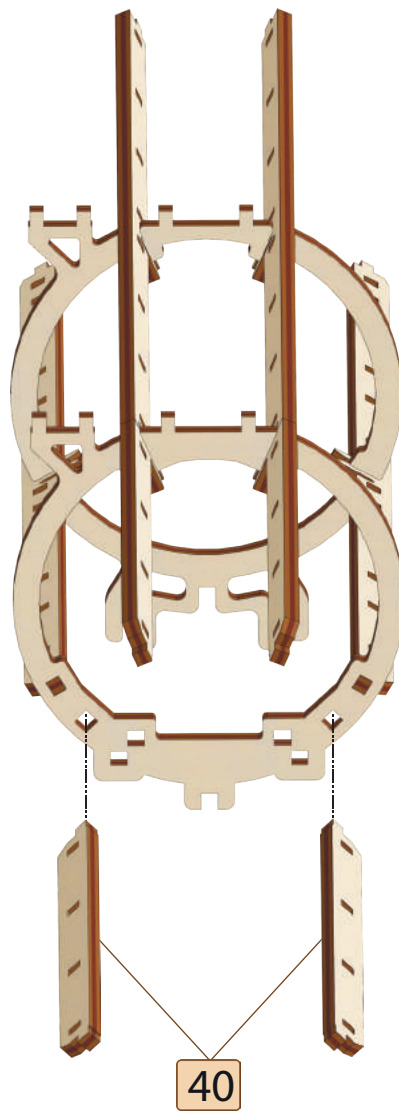

40



[3]

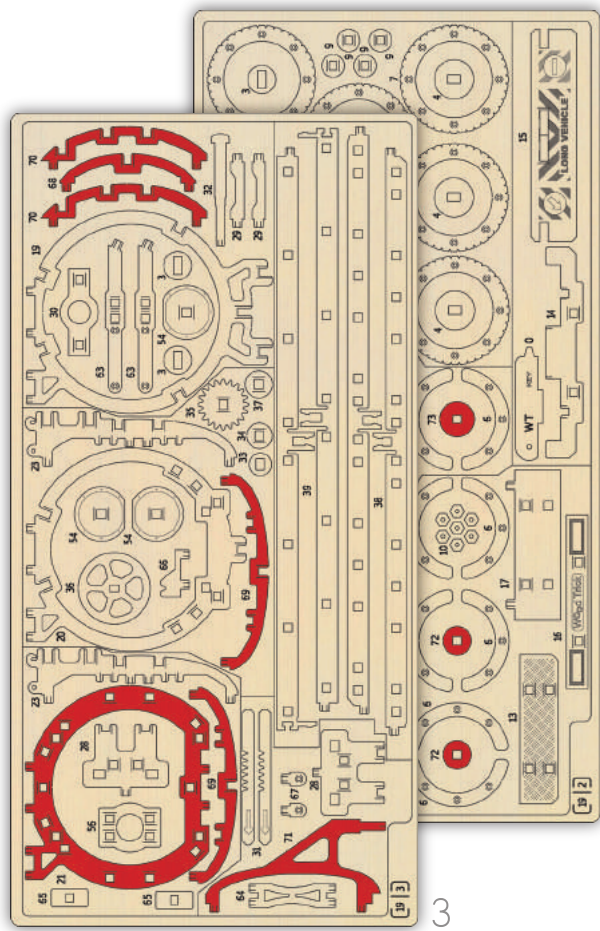

2

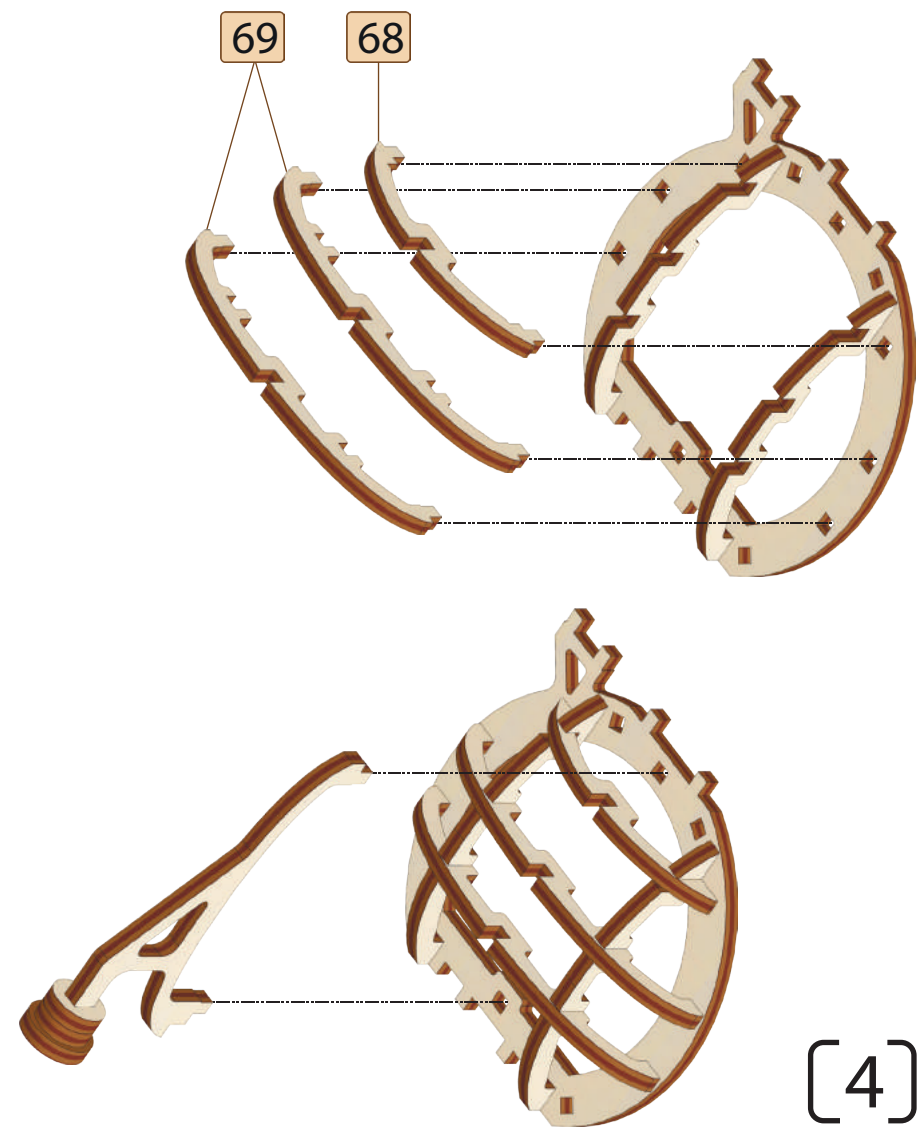
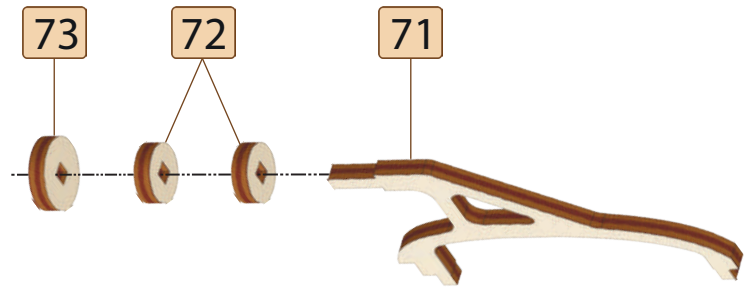
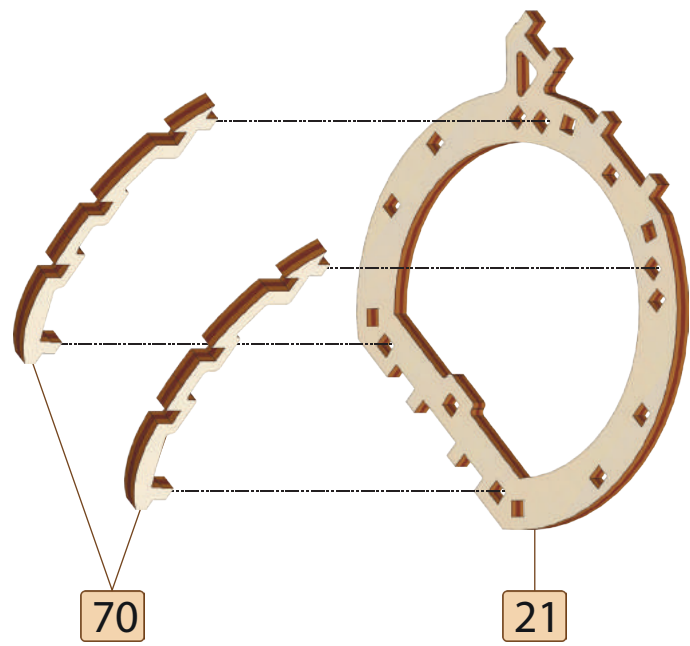

[4]

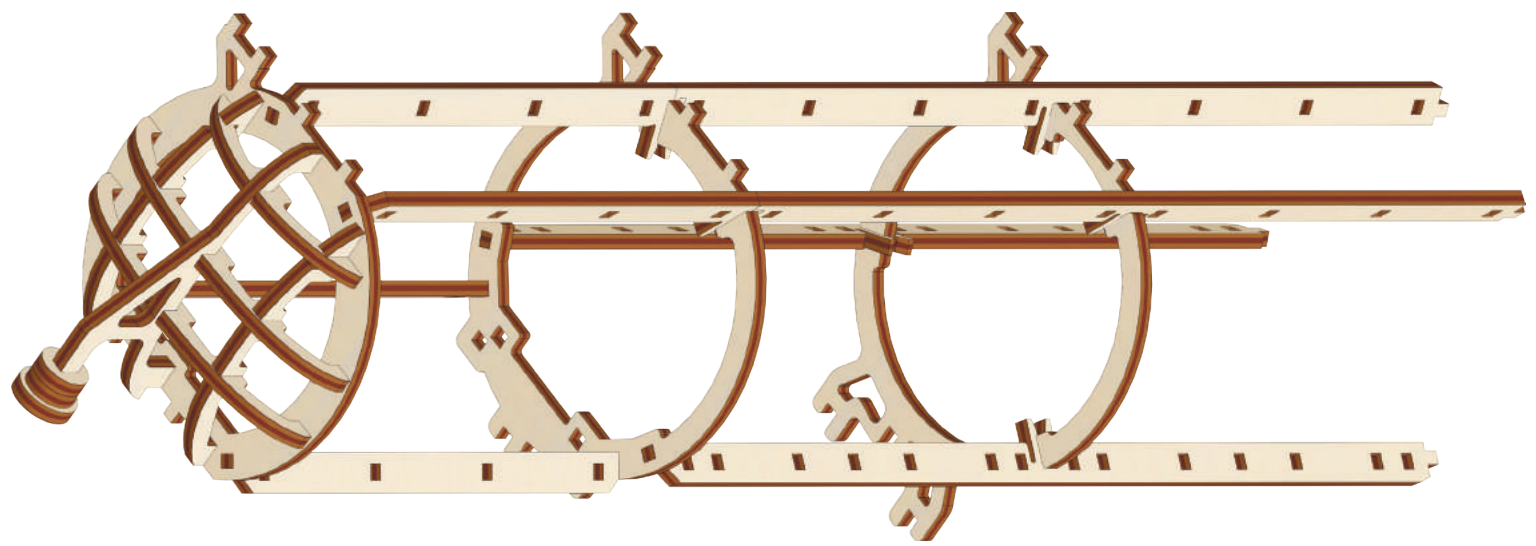
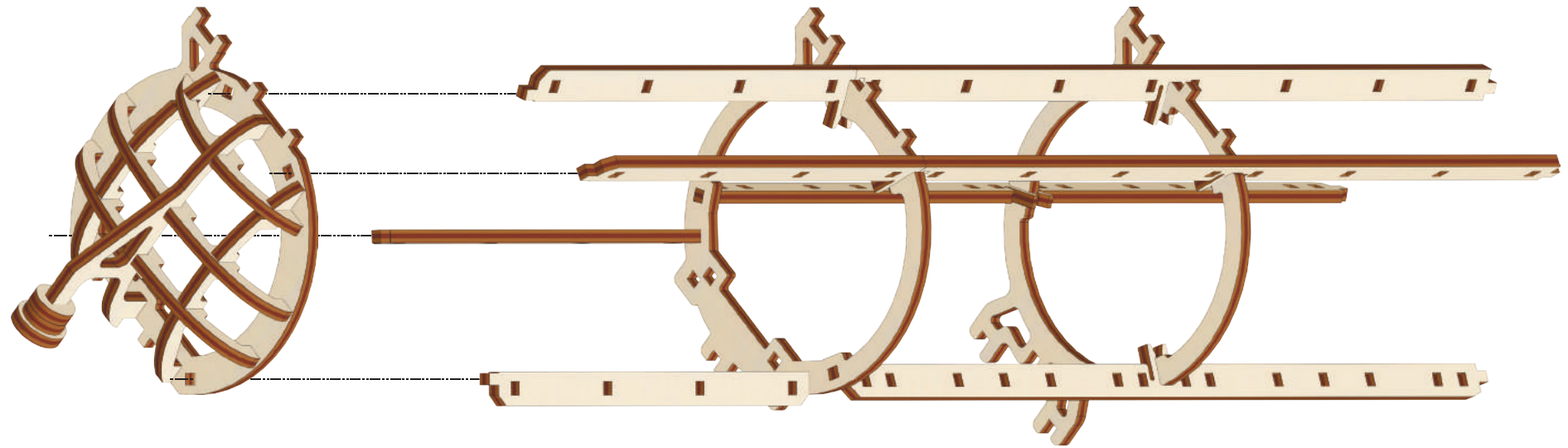

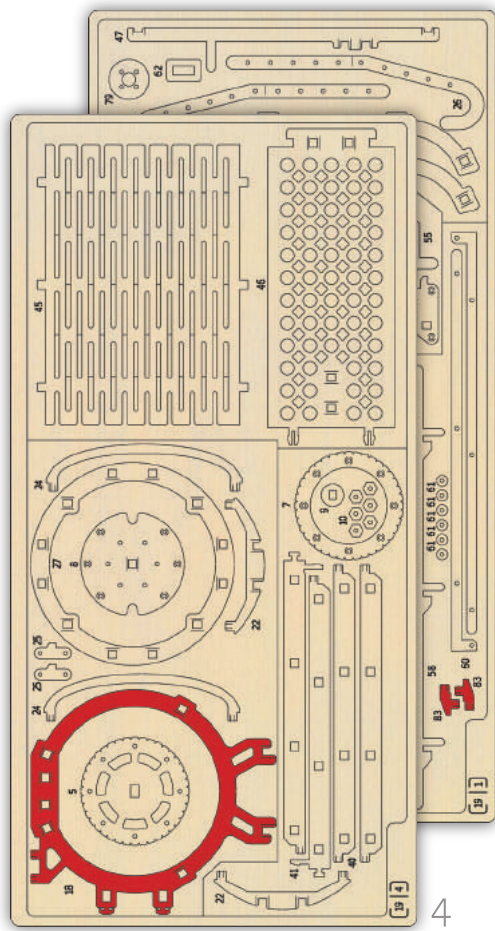

1

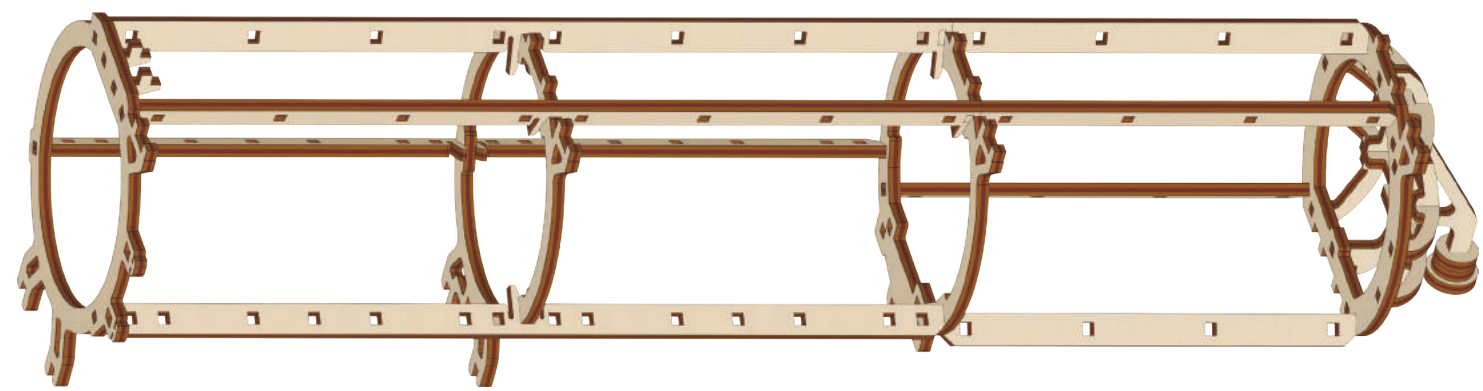
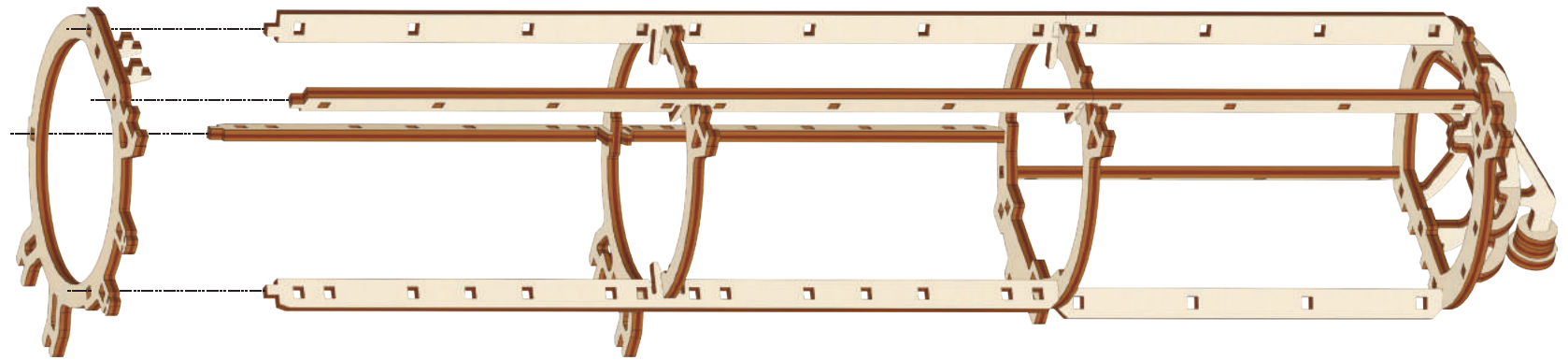
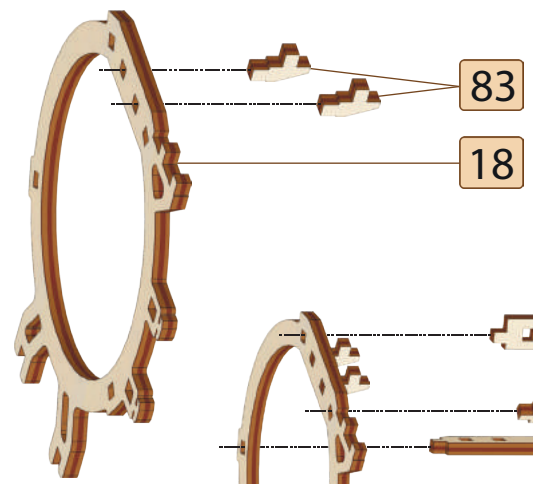

[6]

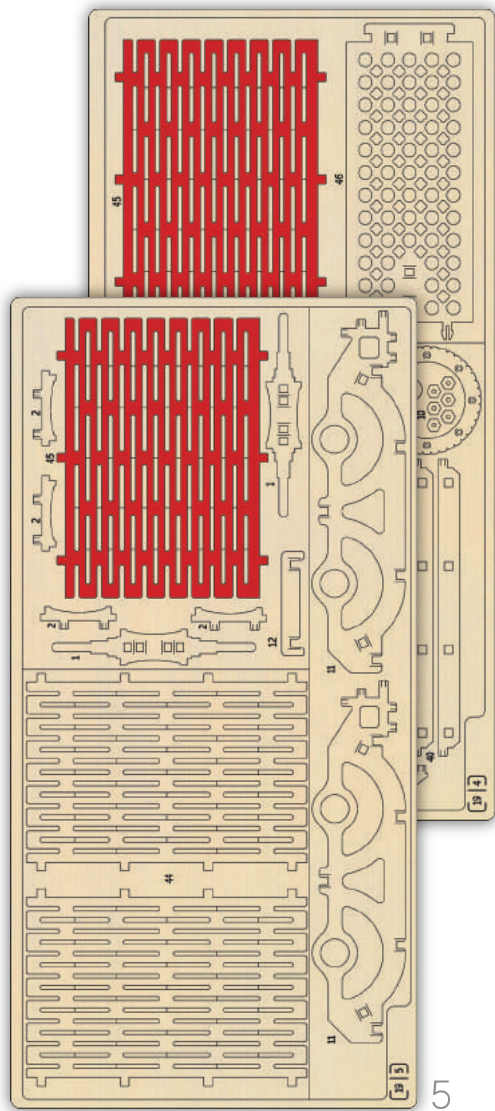

4

5

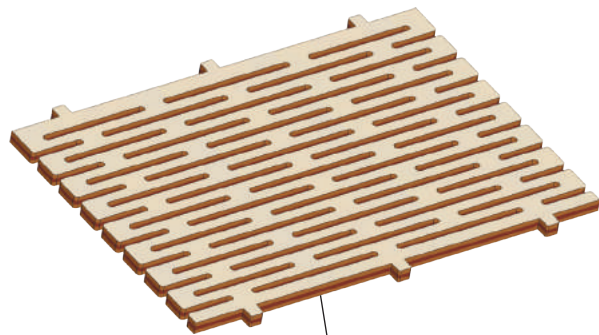

45

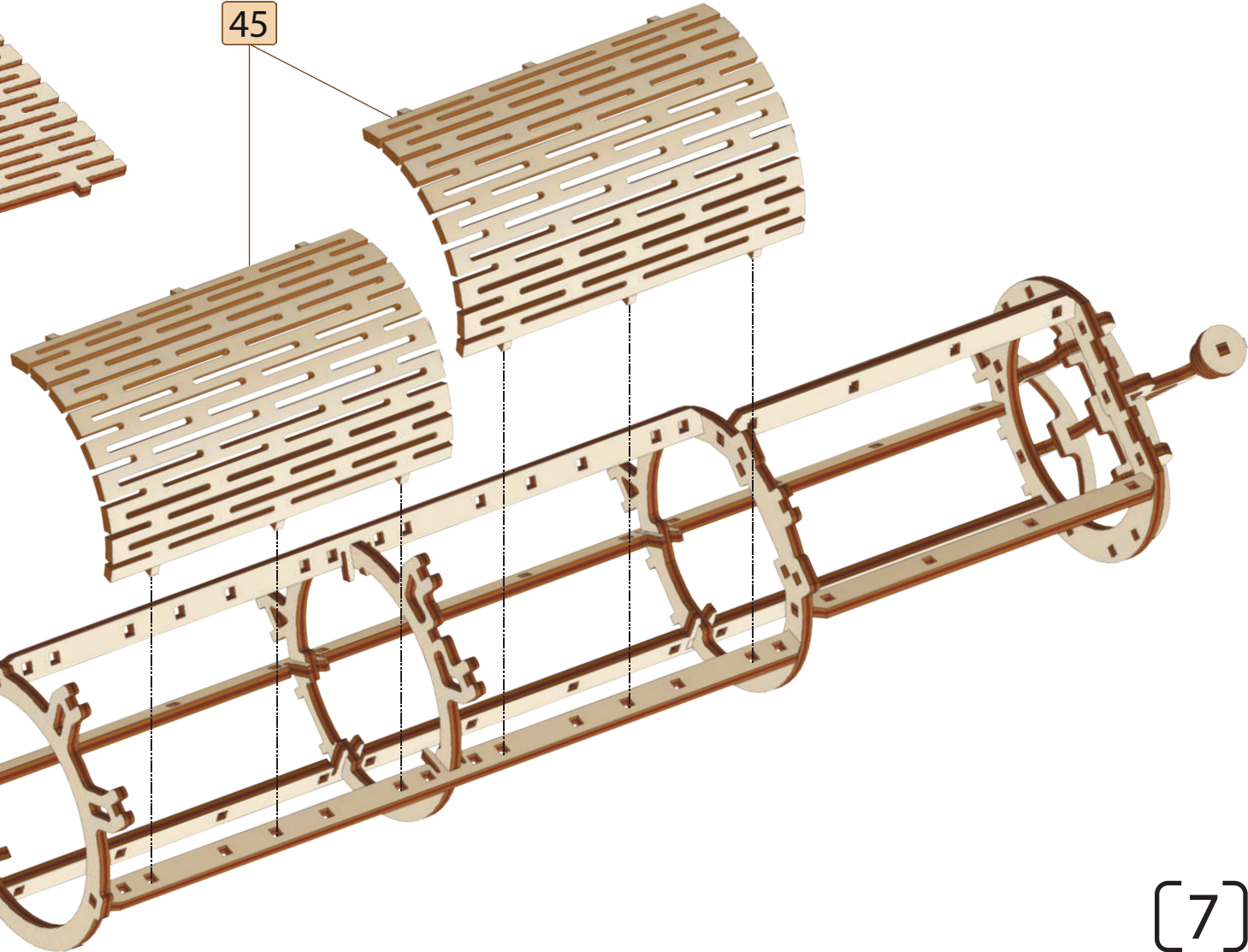
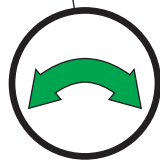

[7]

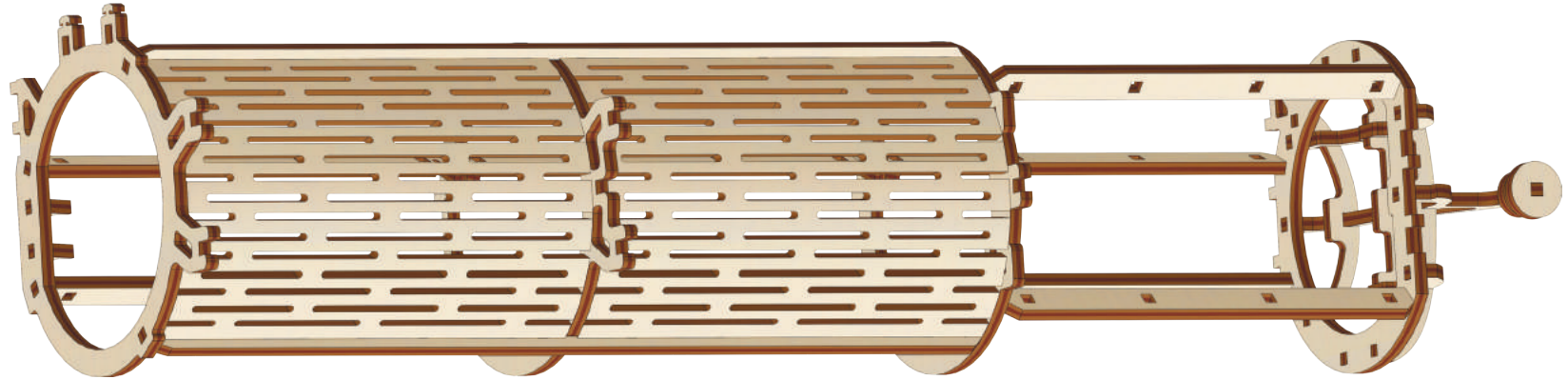
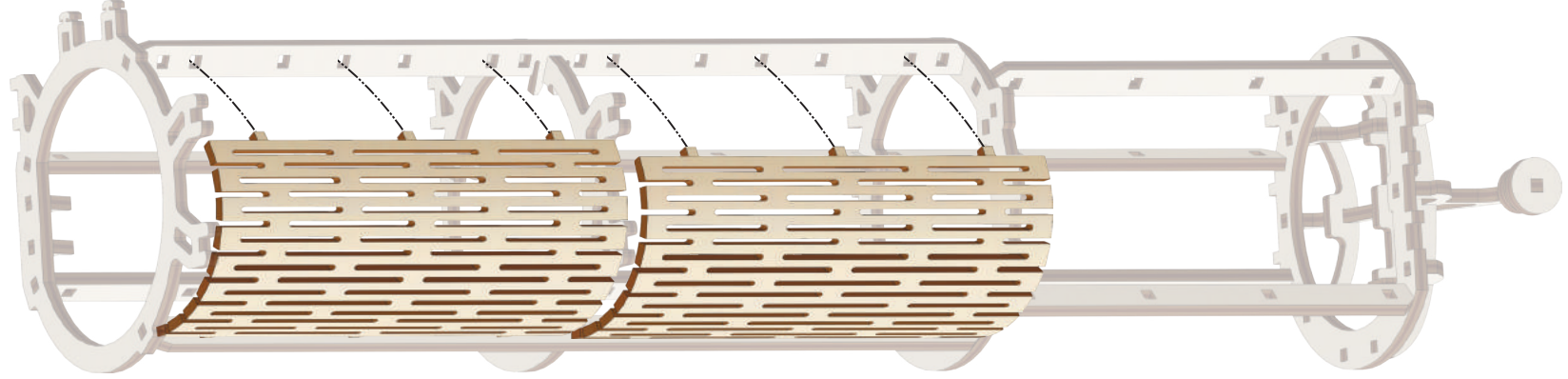

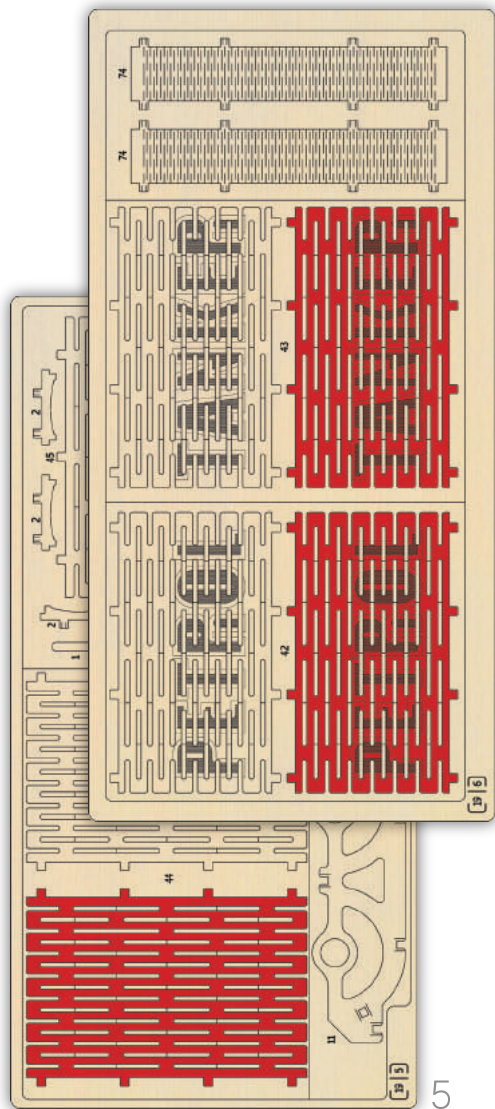

6

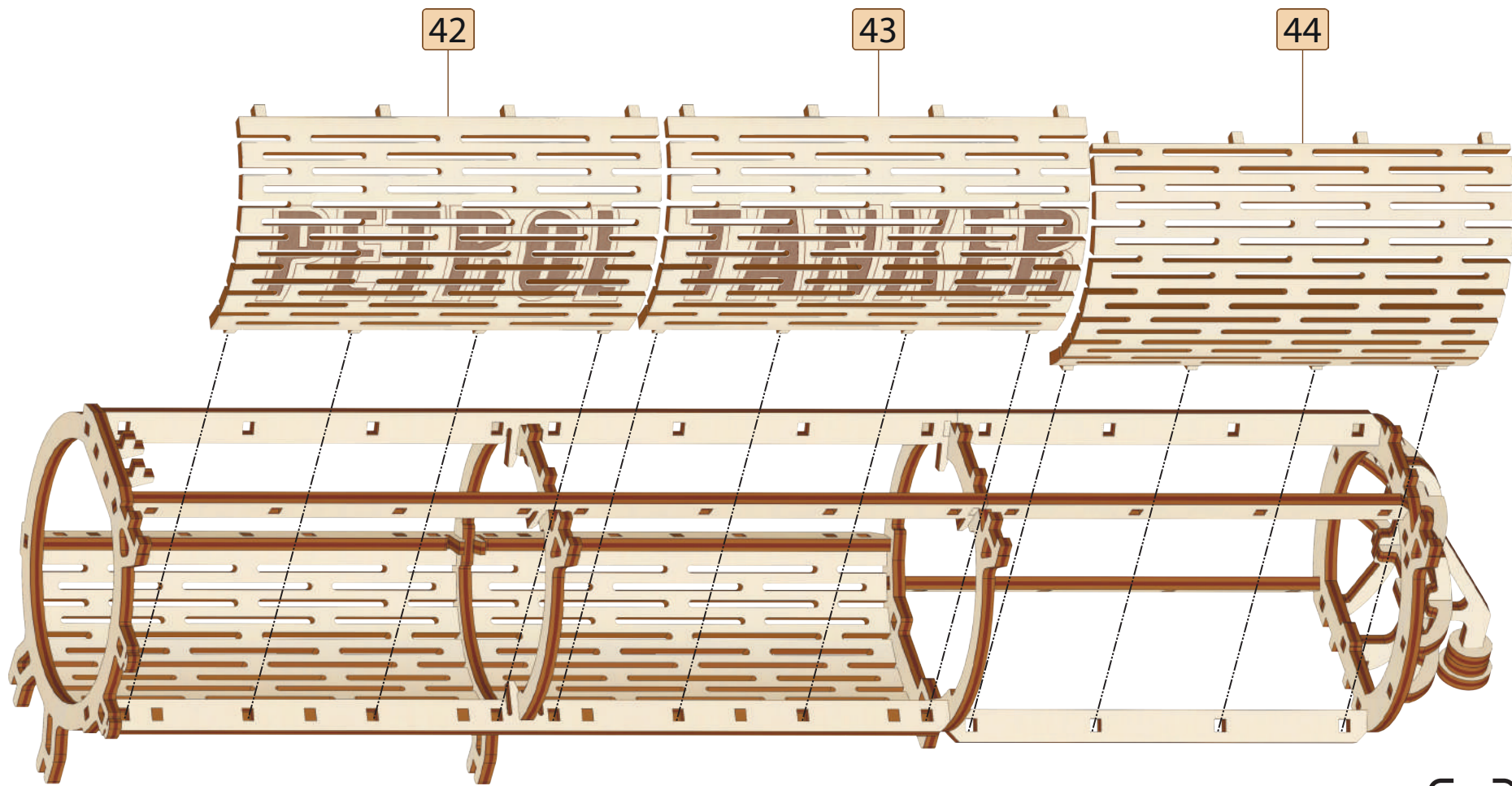

[9]

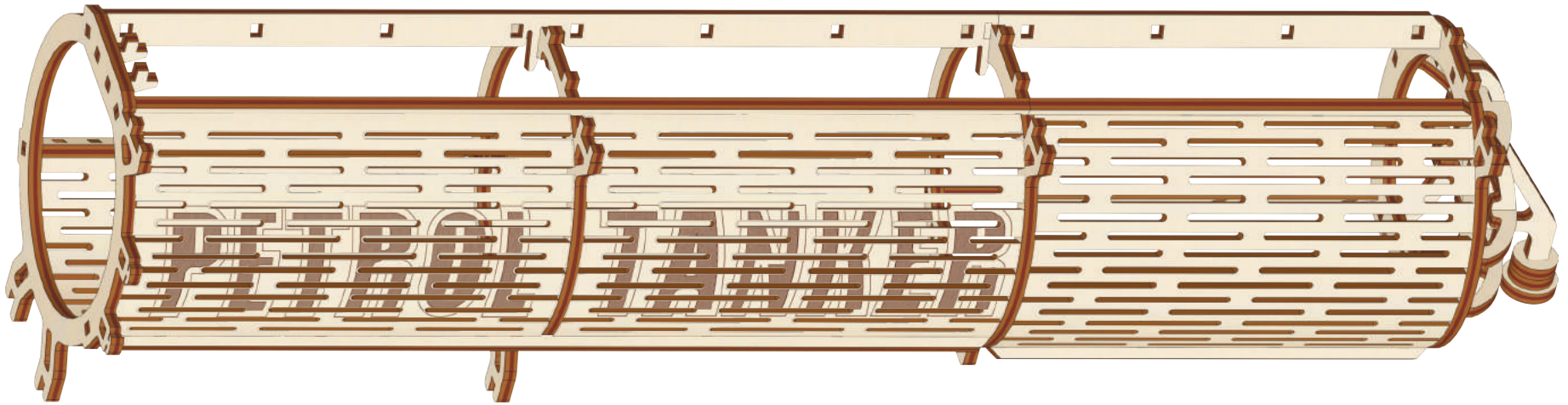
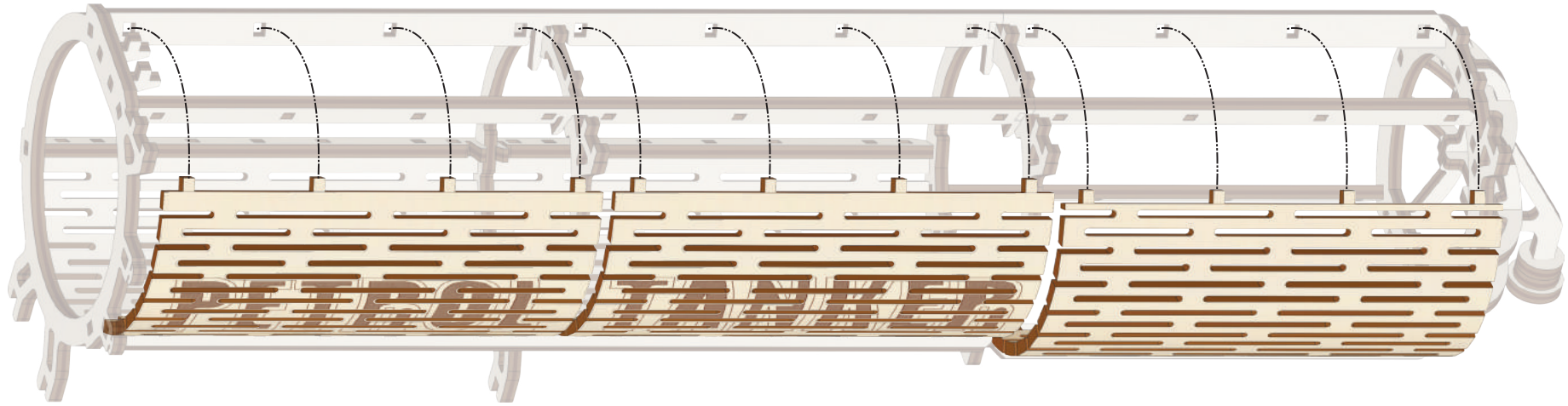

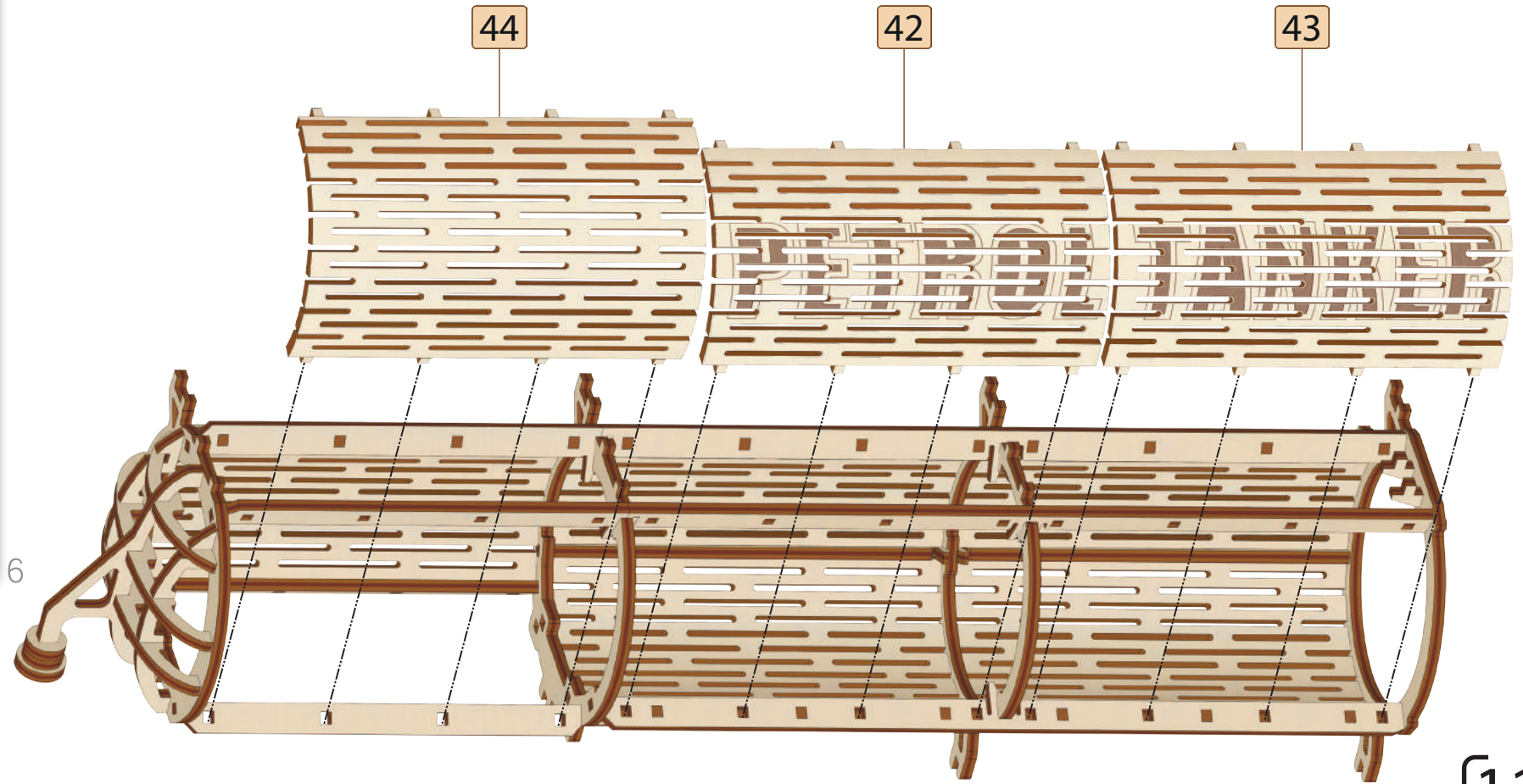
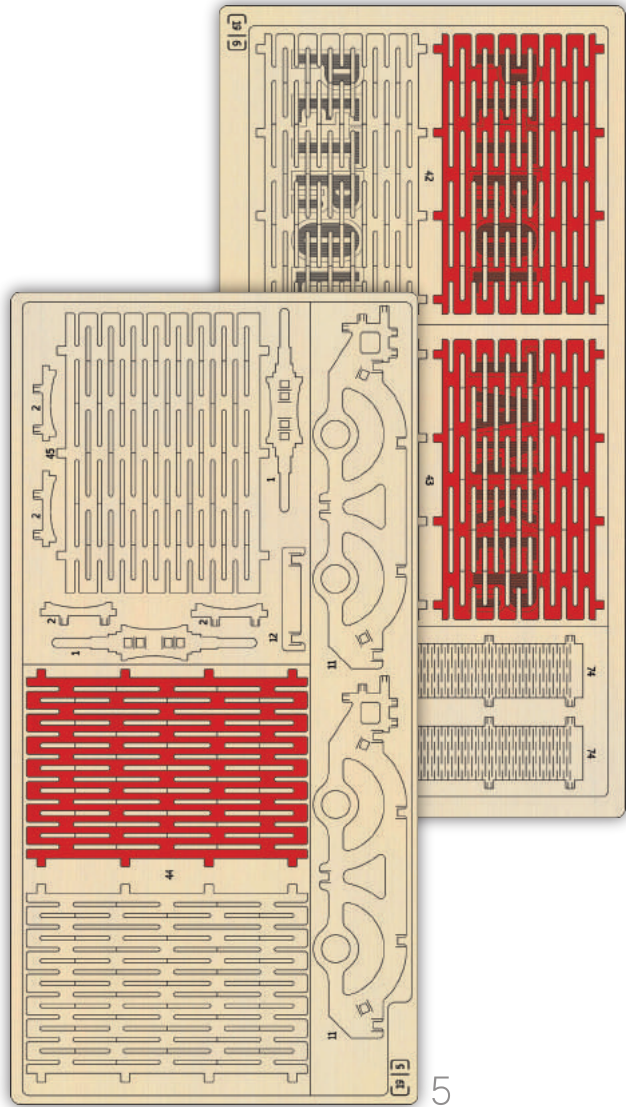

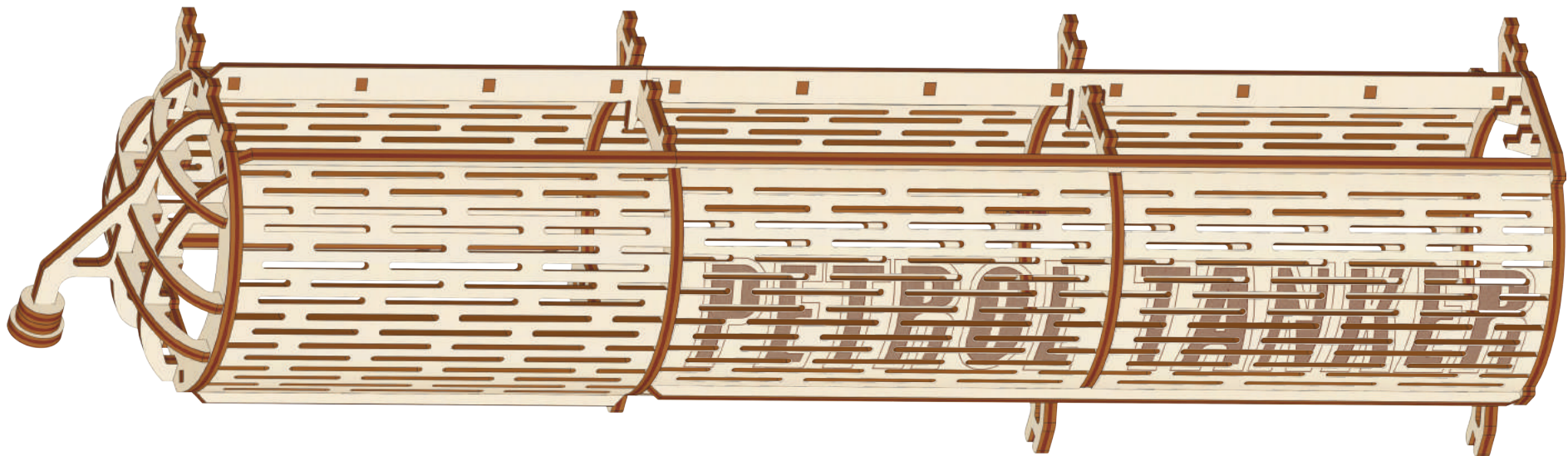
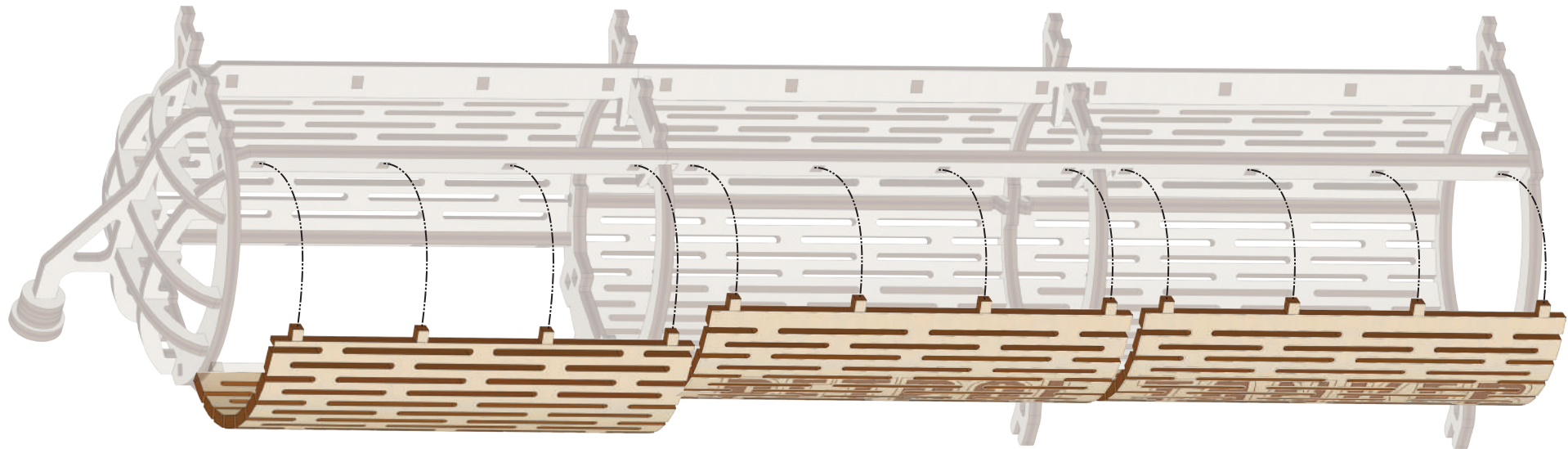

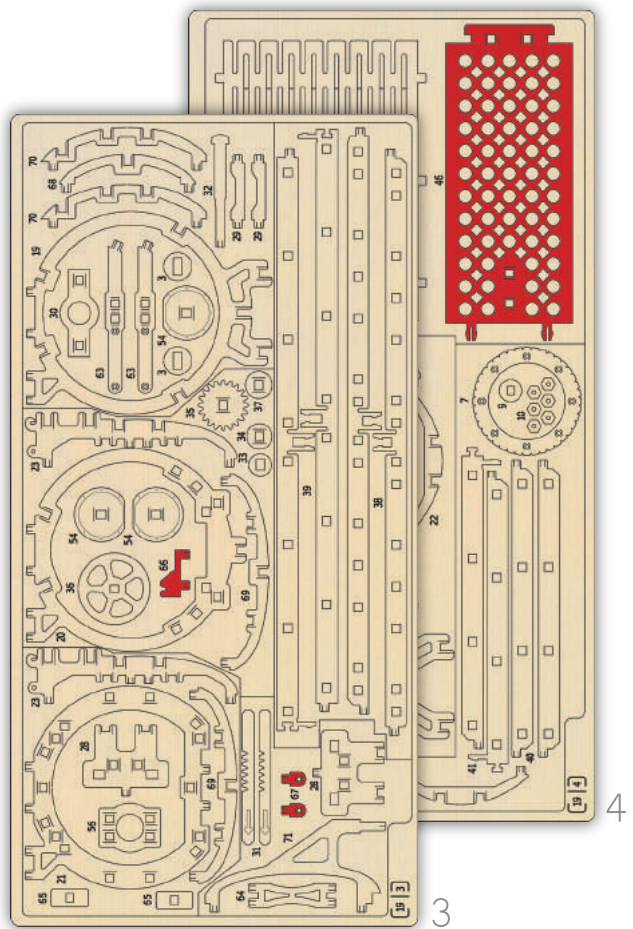

66

46

67

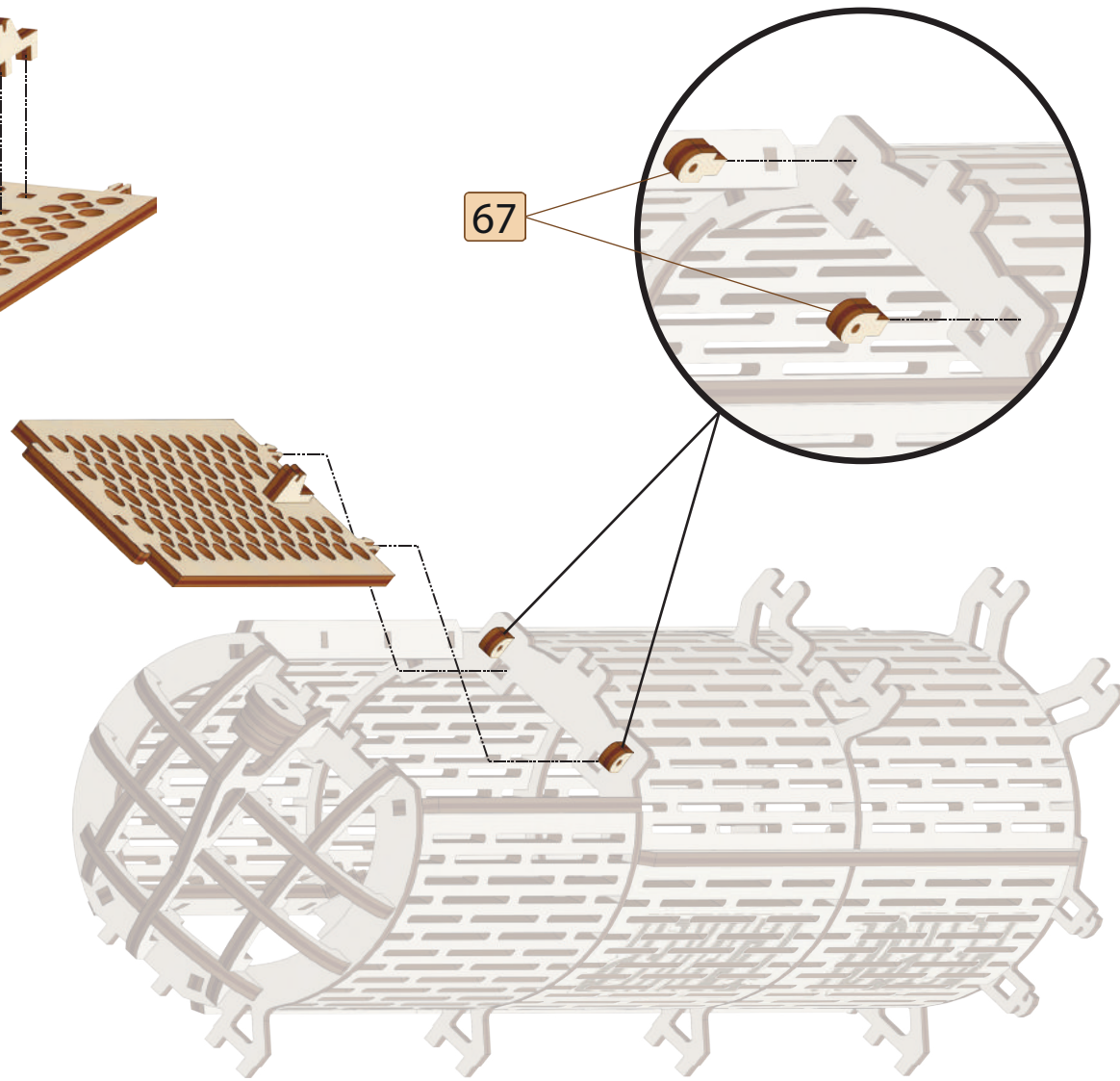

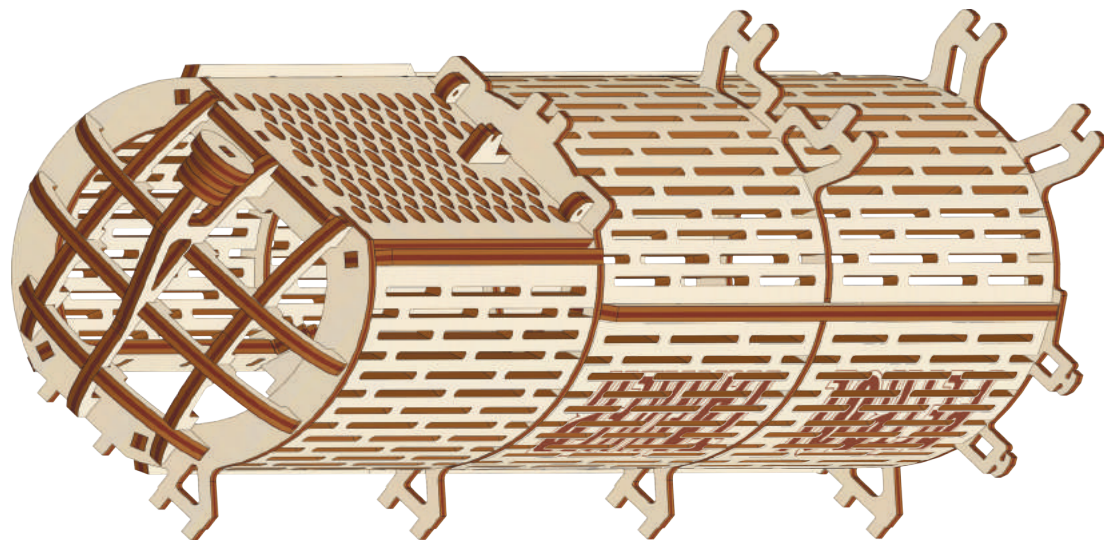
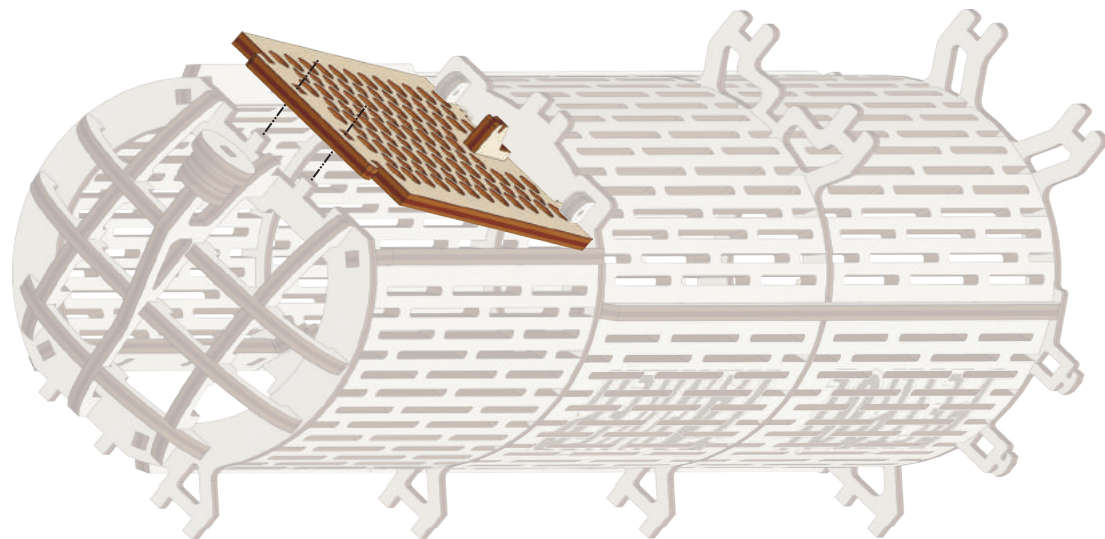

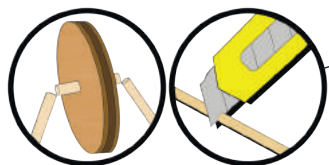
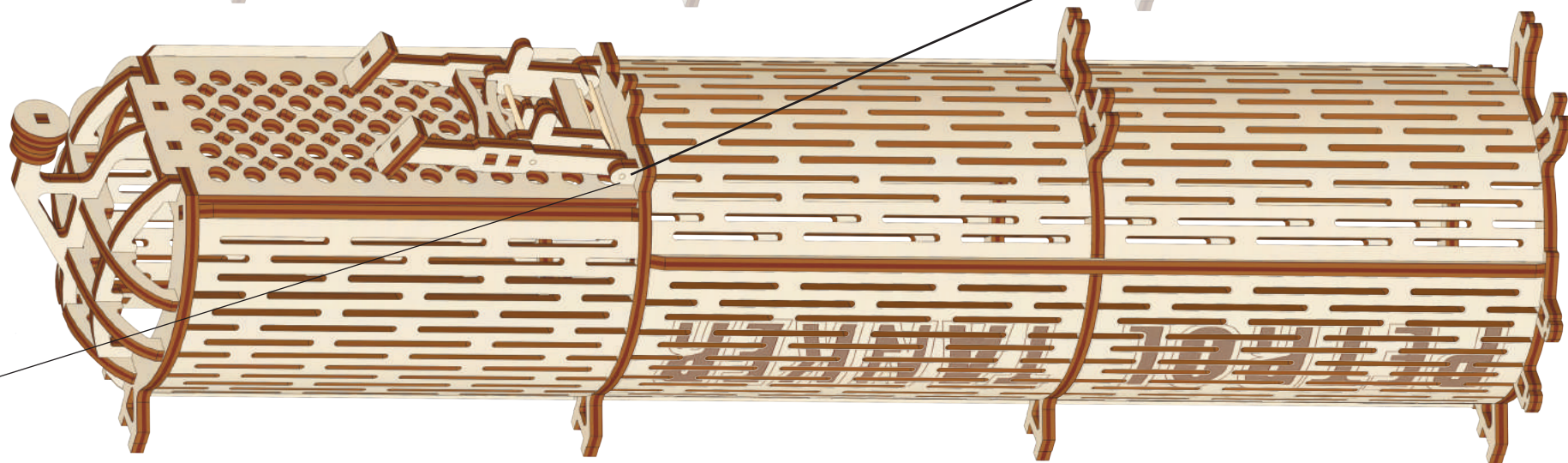
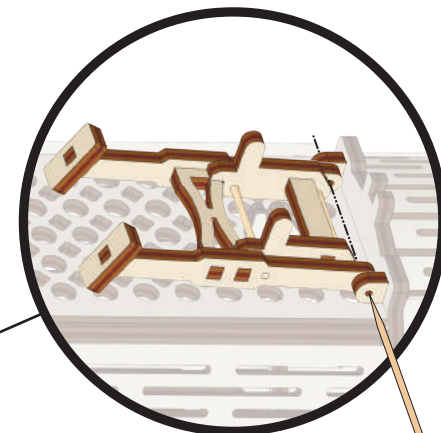
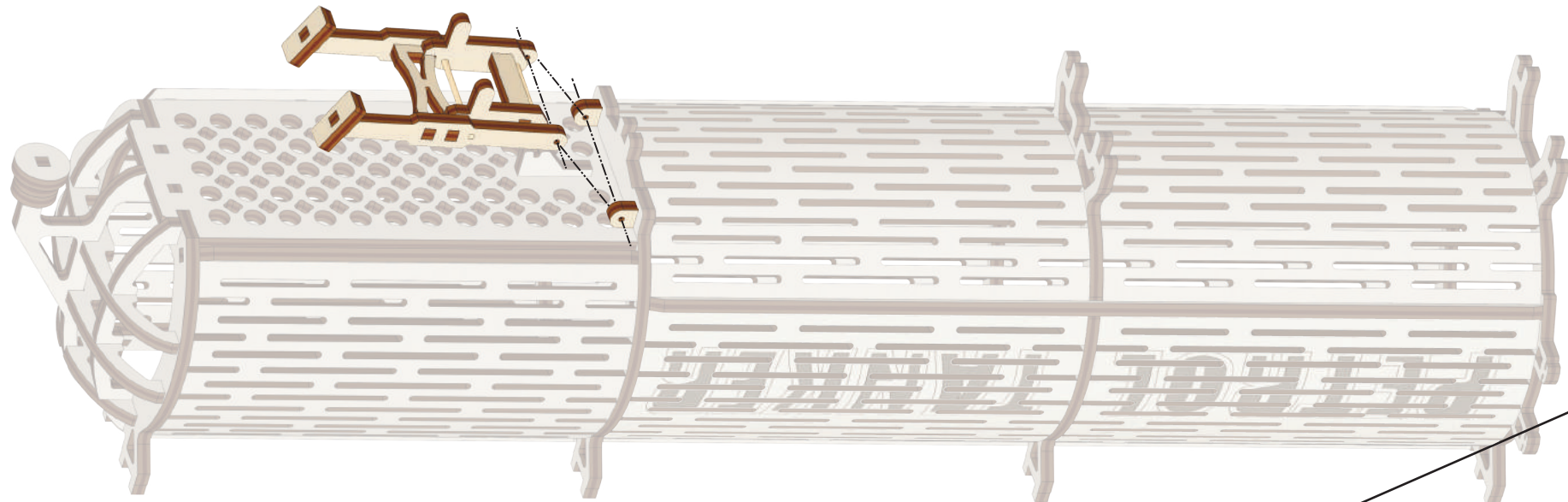

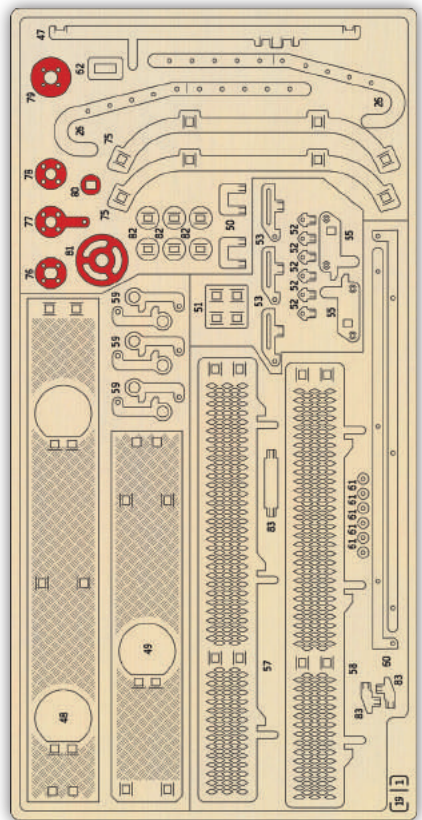

1

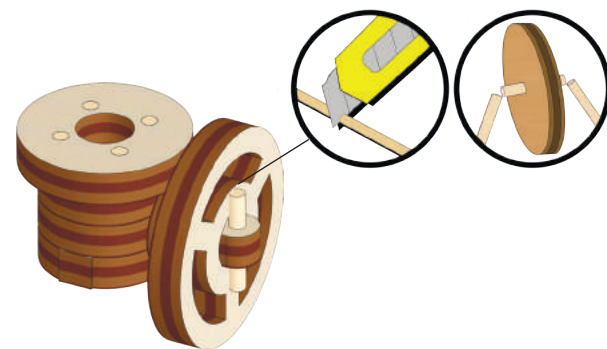
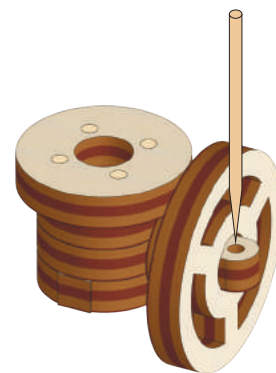
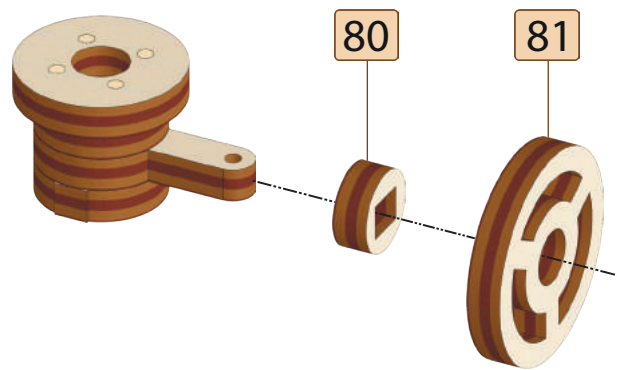
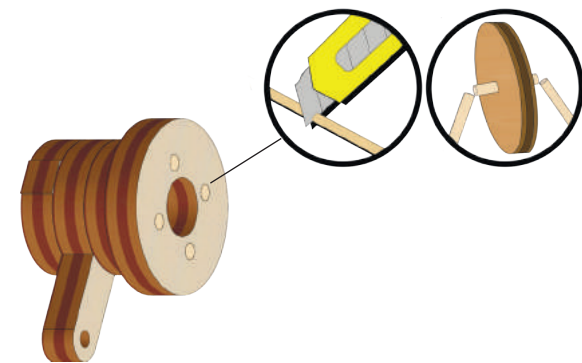
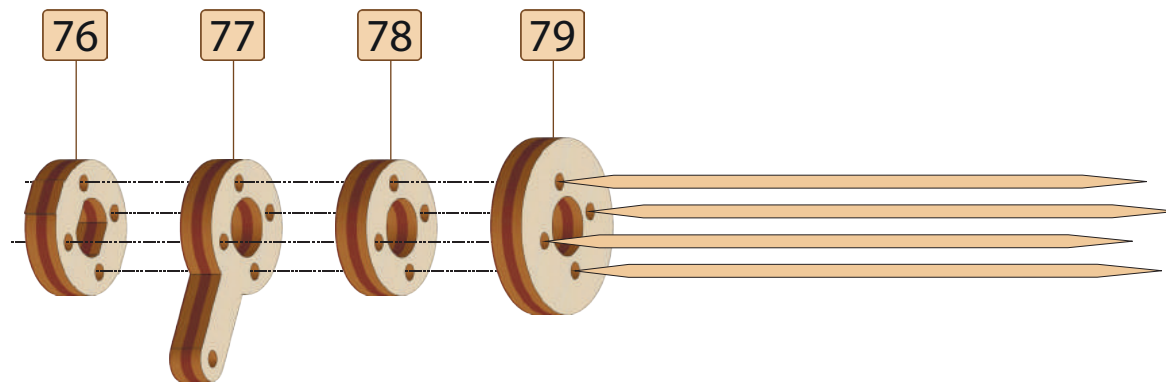

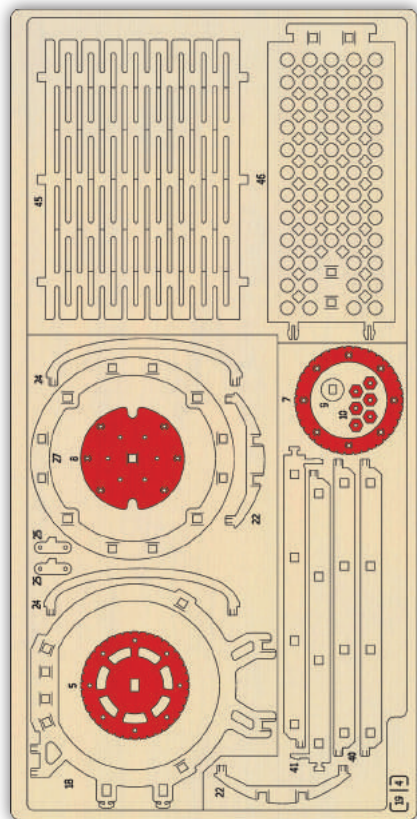

4

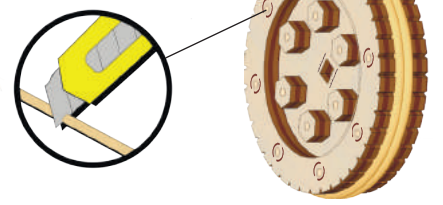
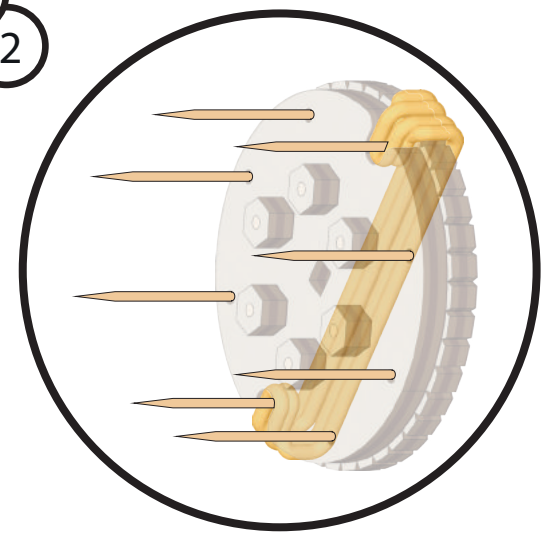
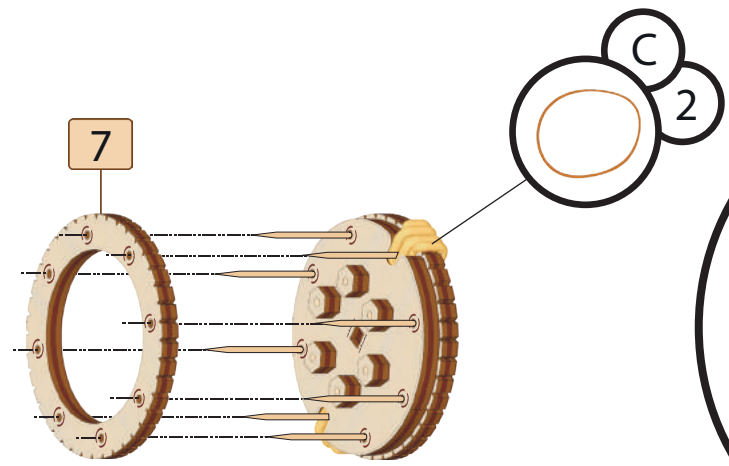
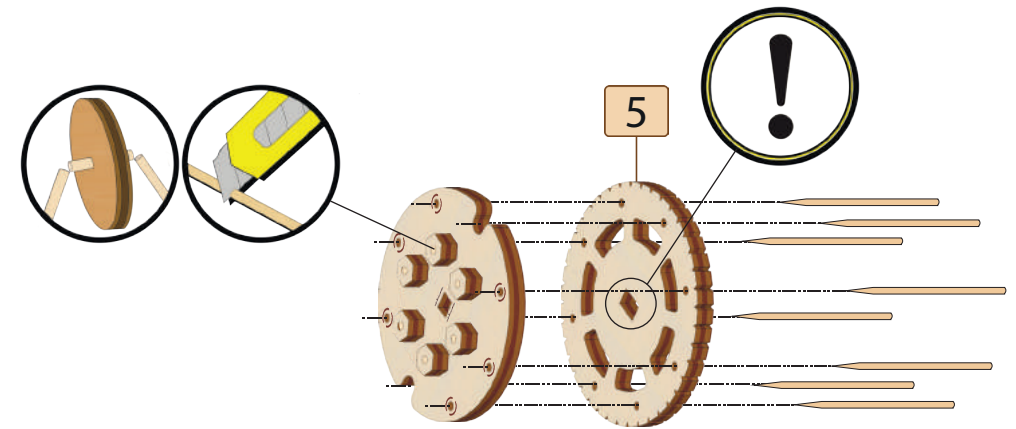
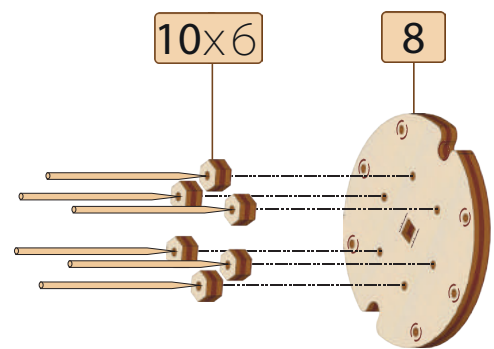

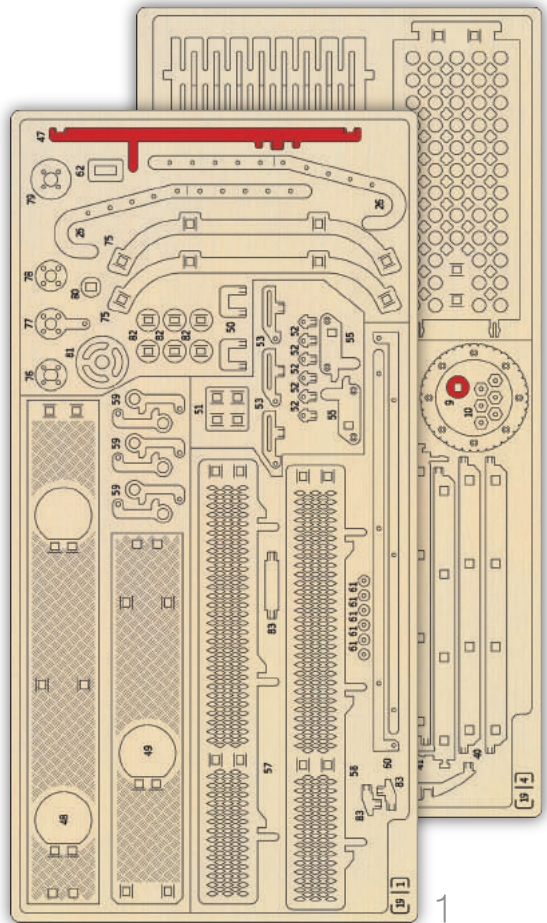

4

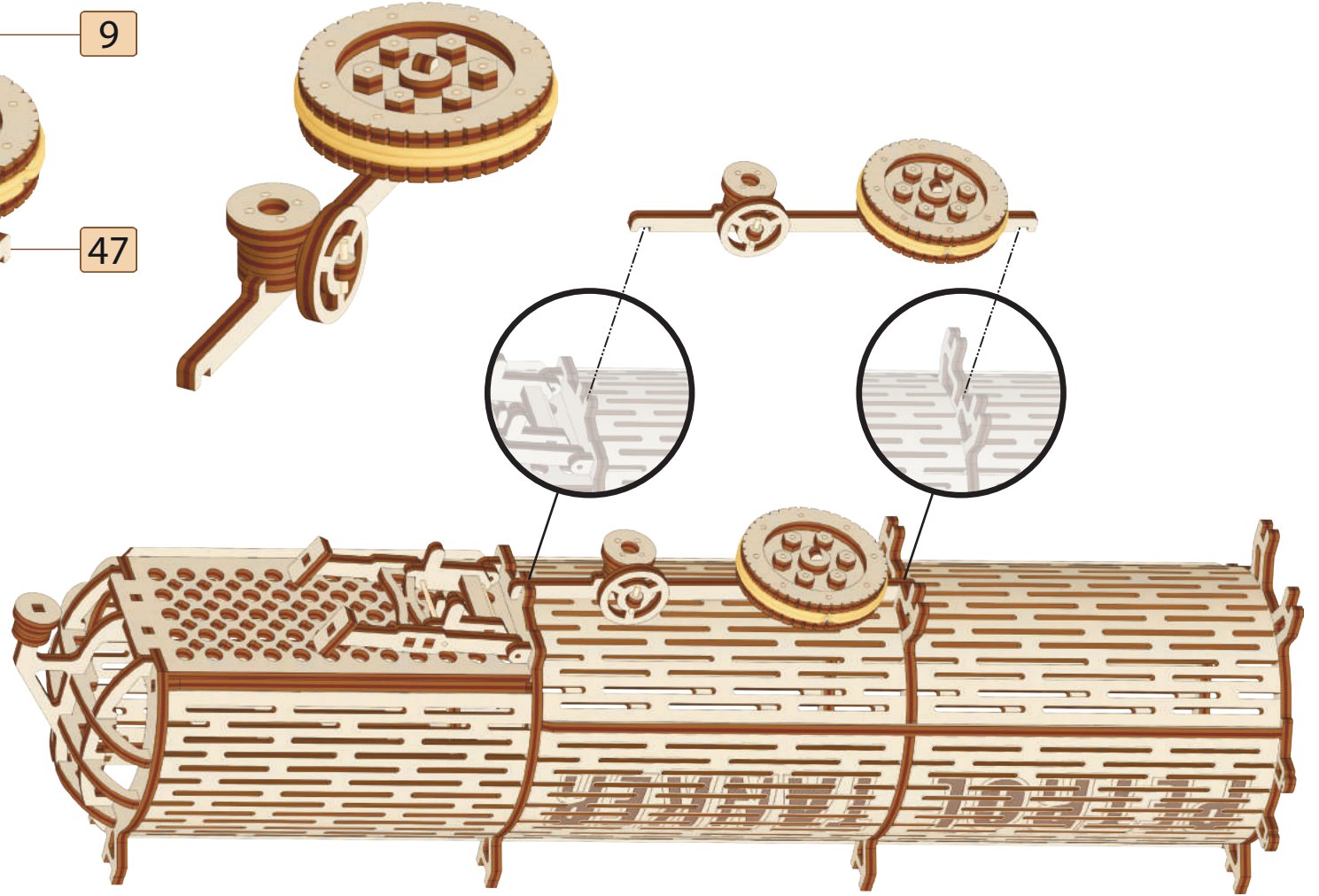
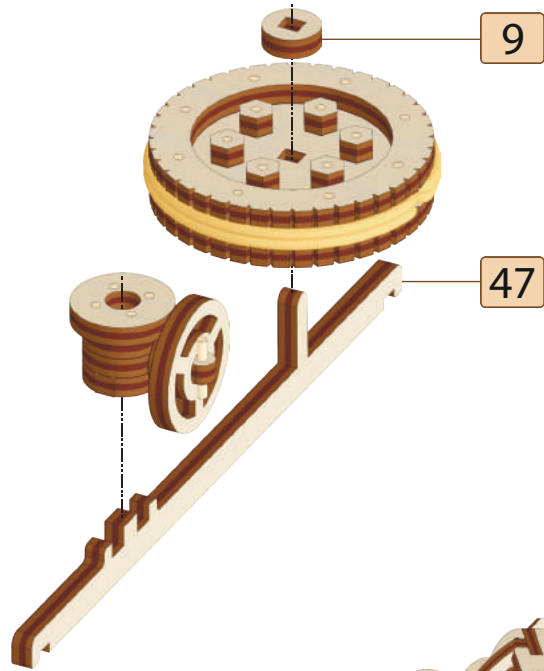

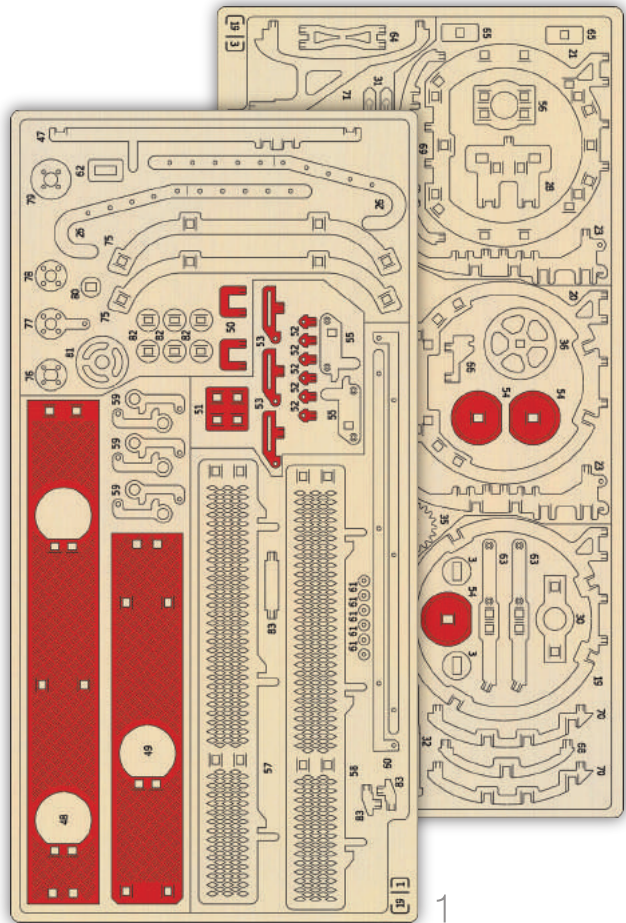

1

3

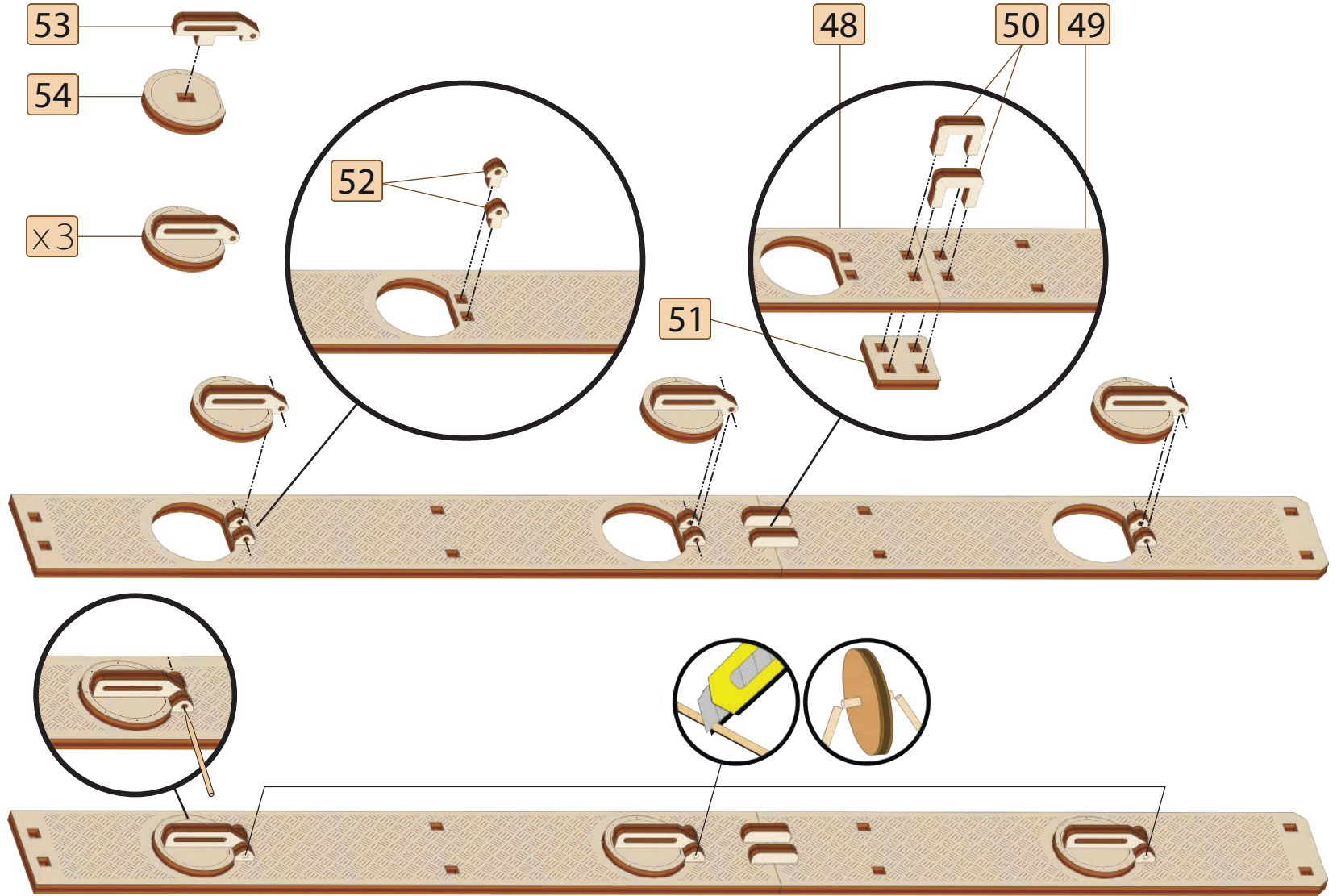

[20]

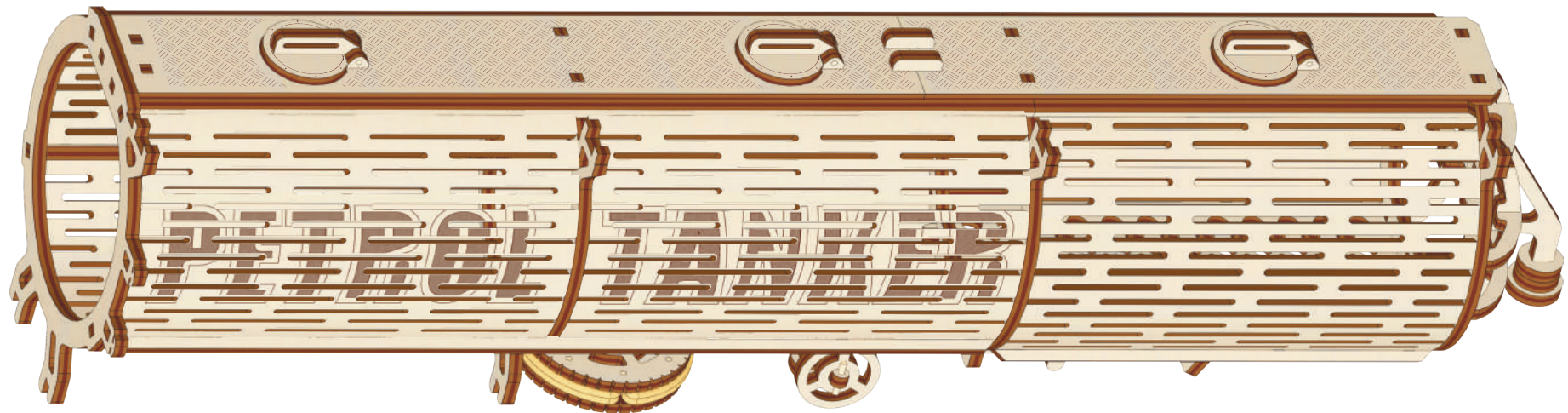
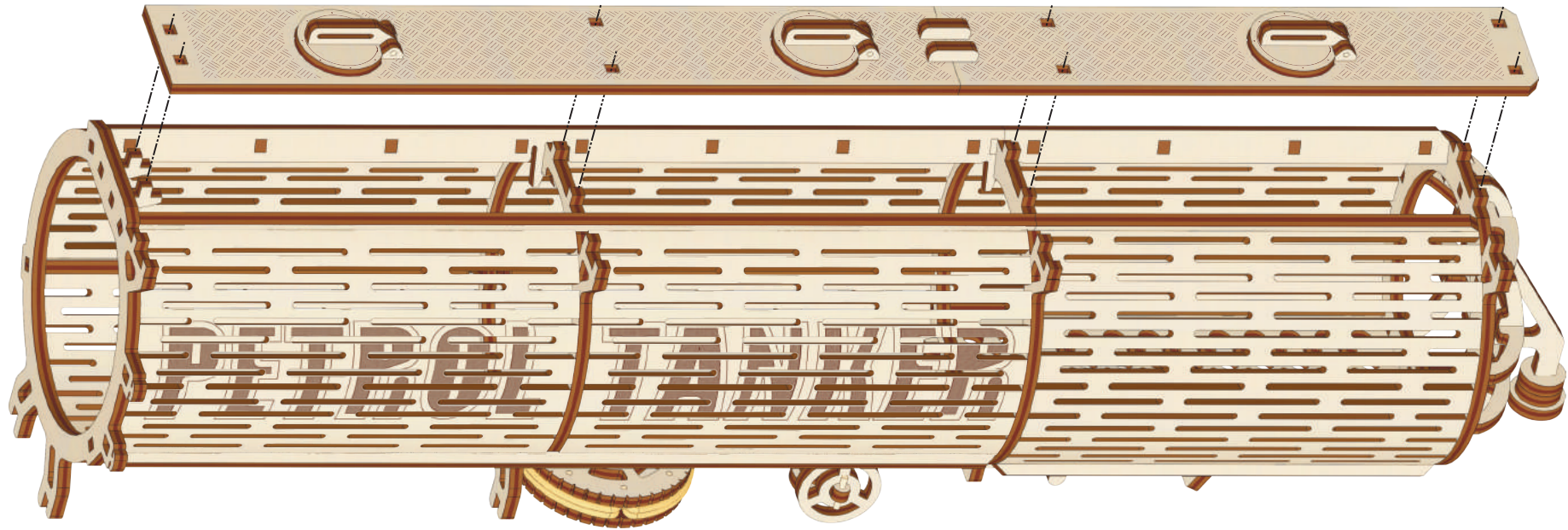

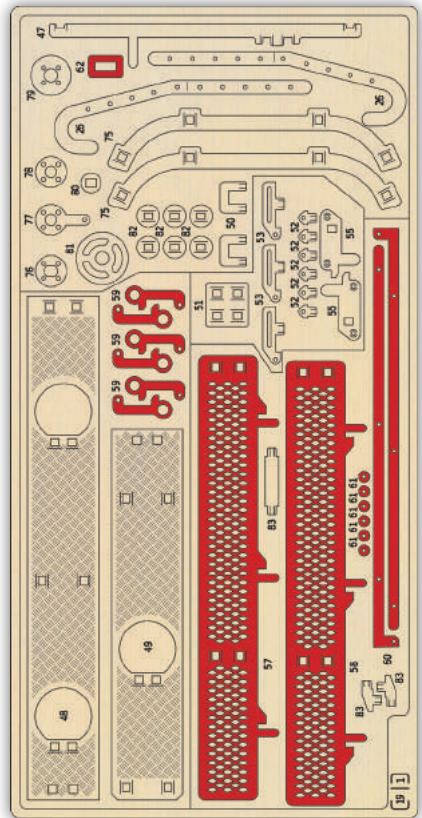

1

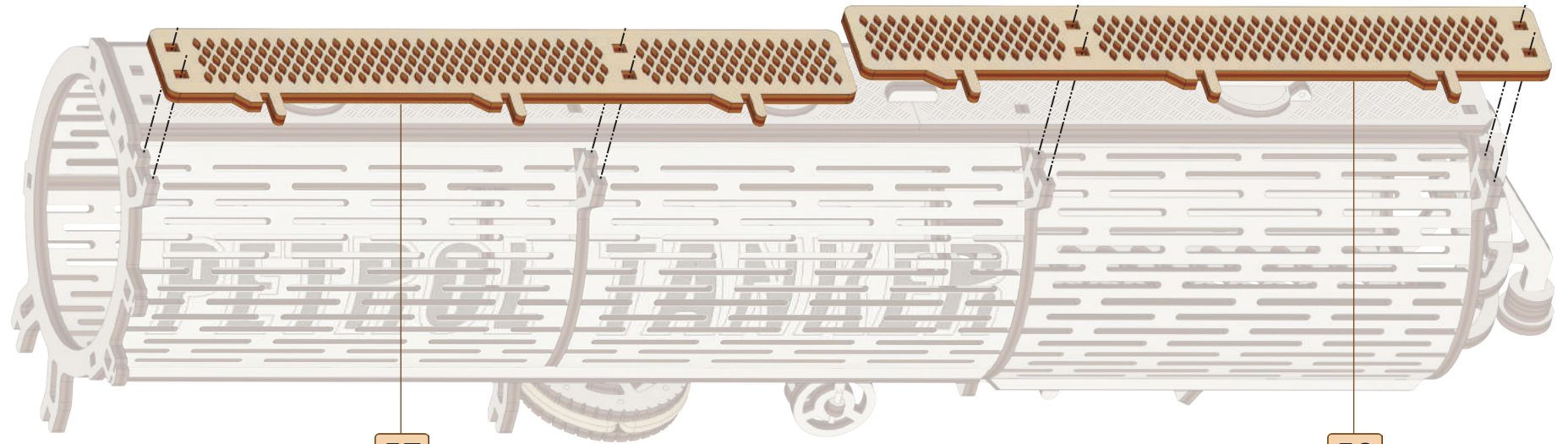

57

58

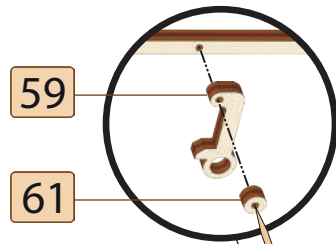

59

61

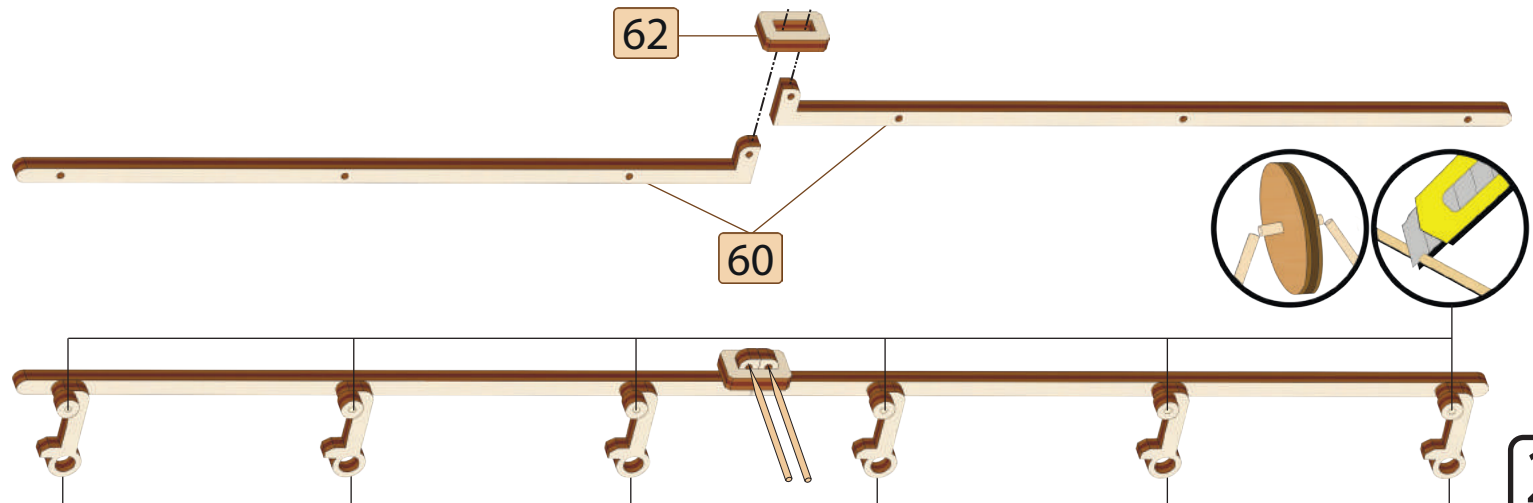

62

60

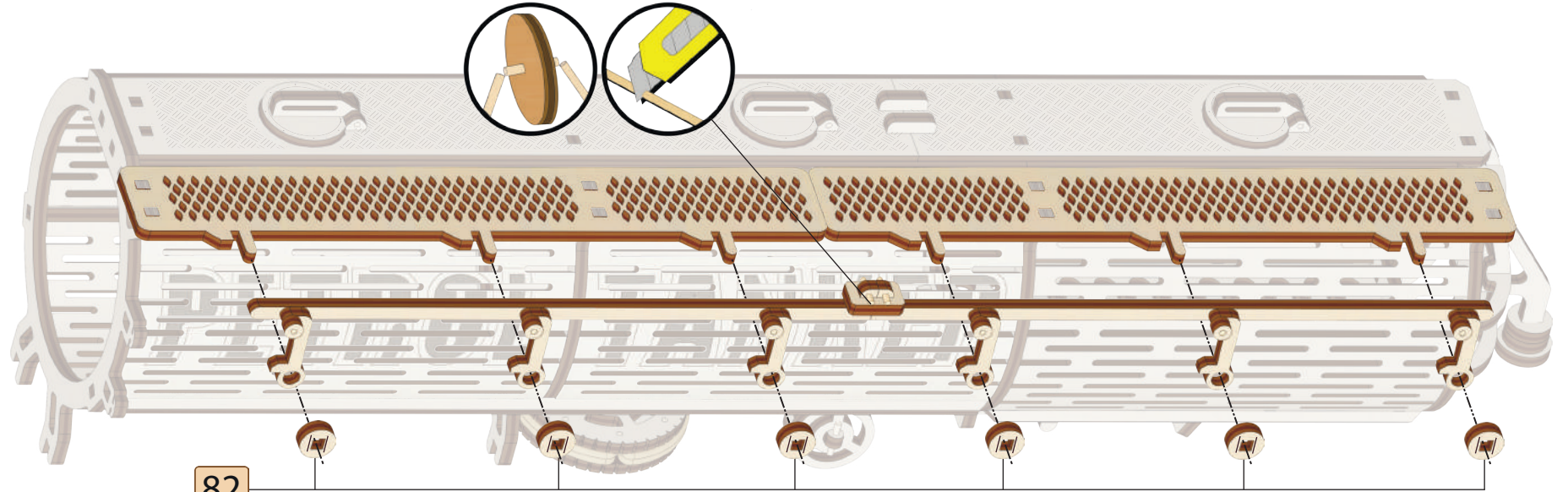
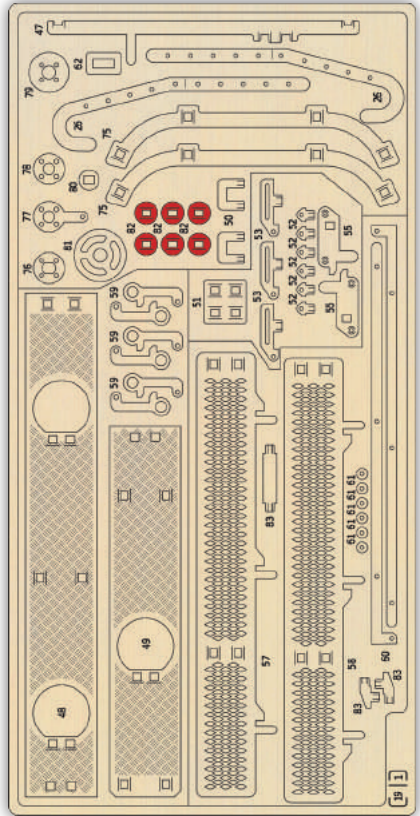

82

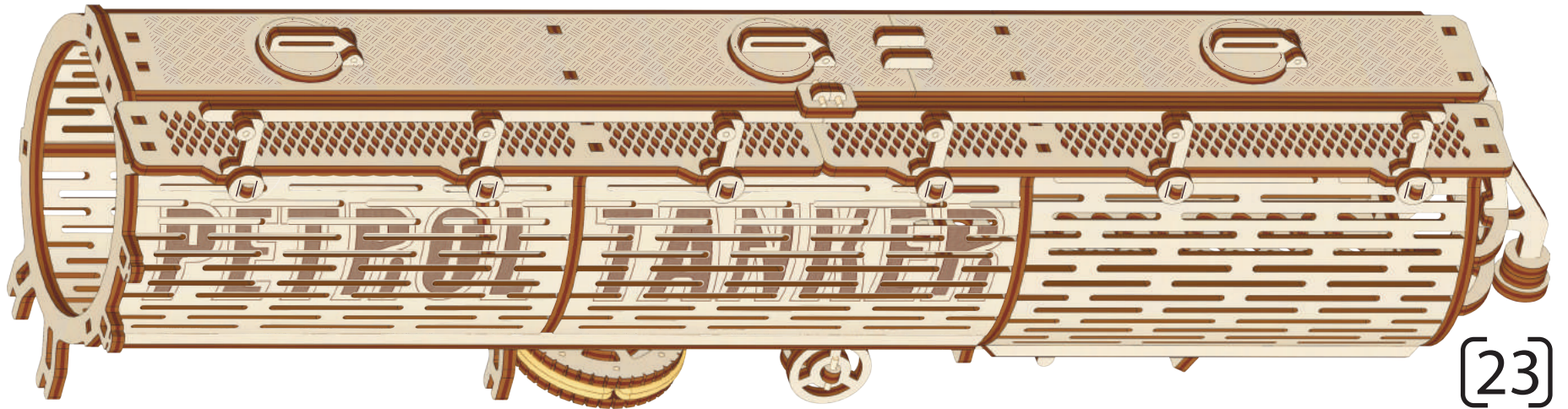

[23]

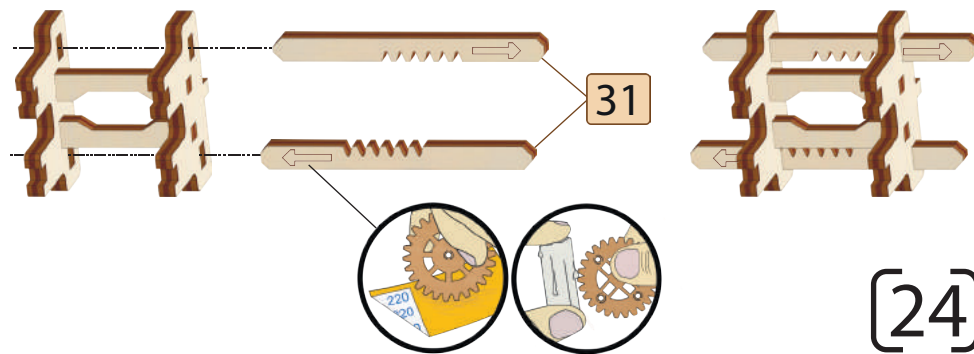
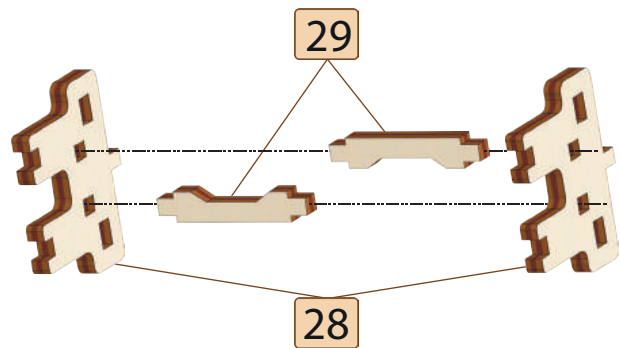
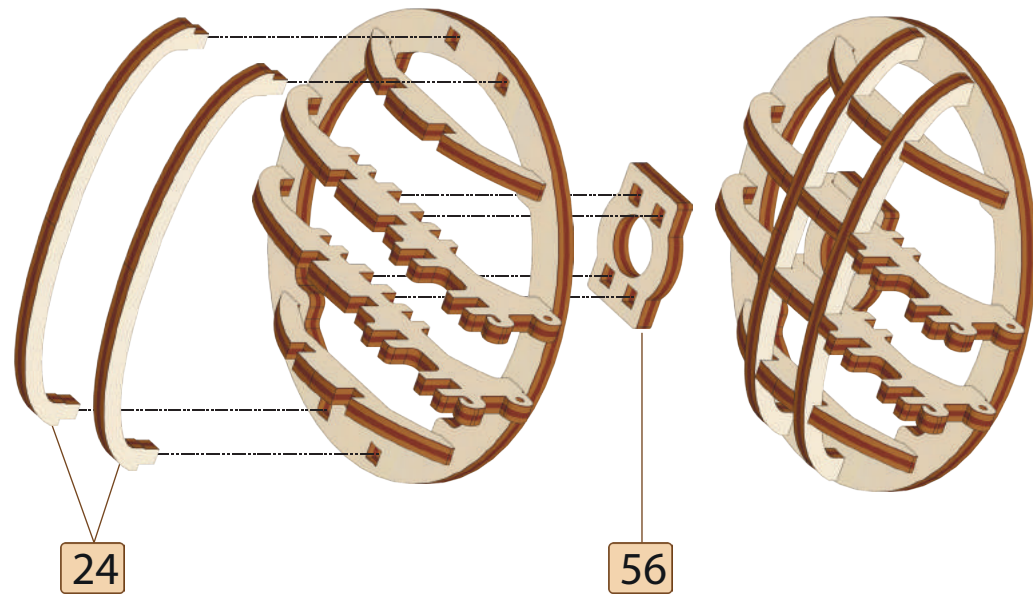
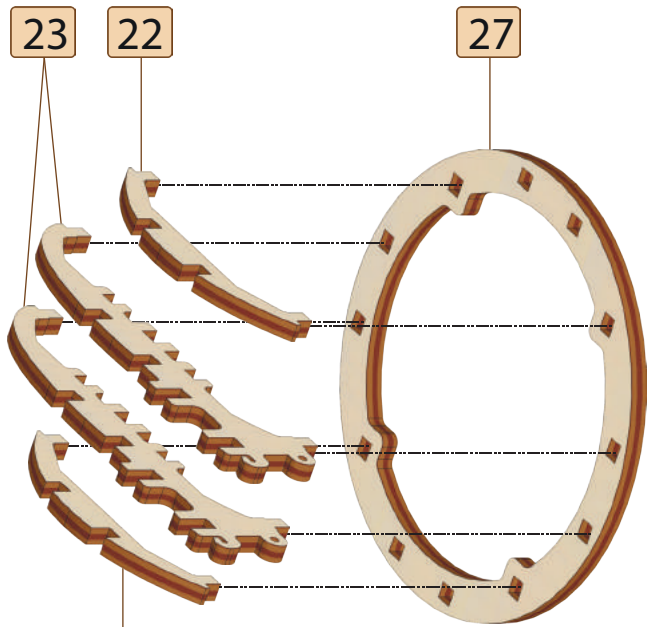
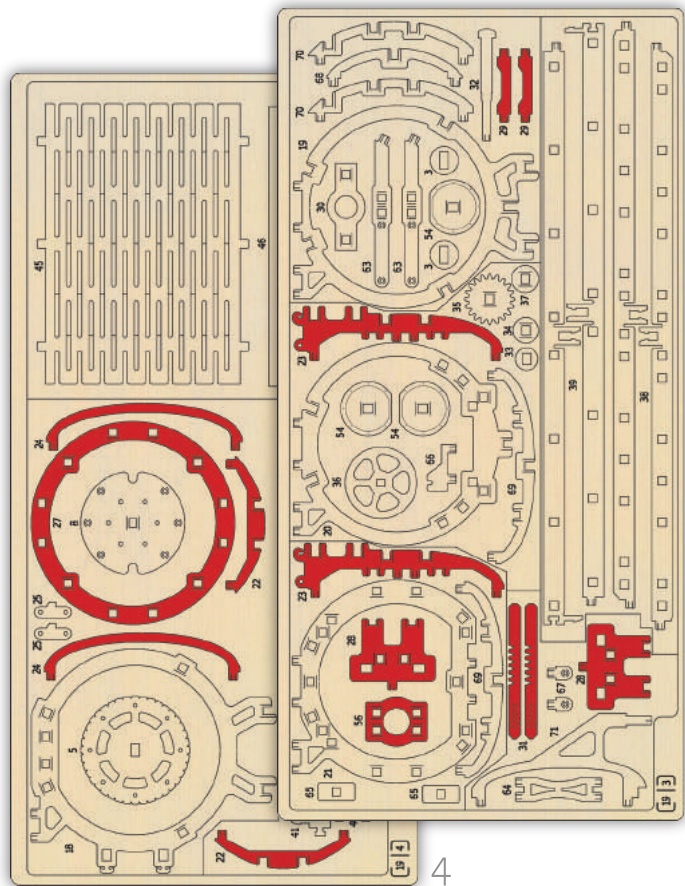

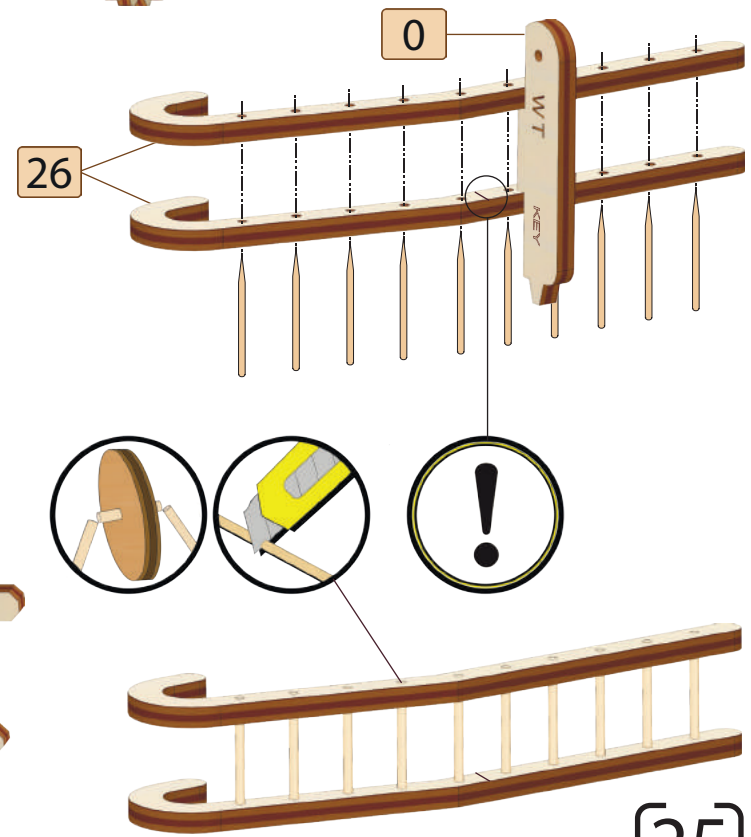
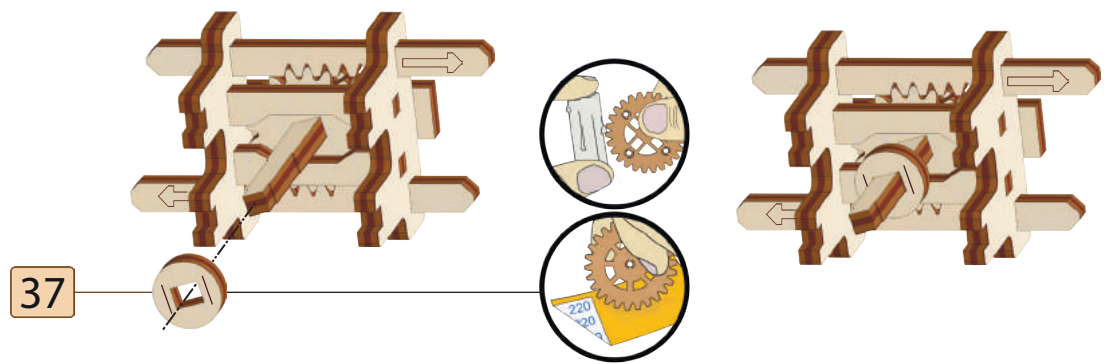
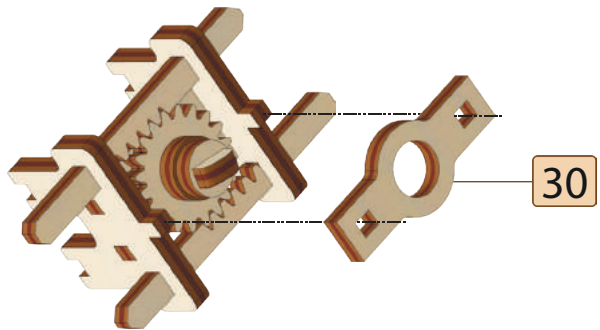
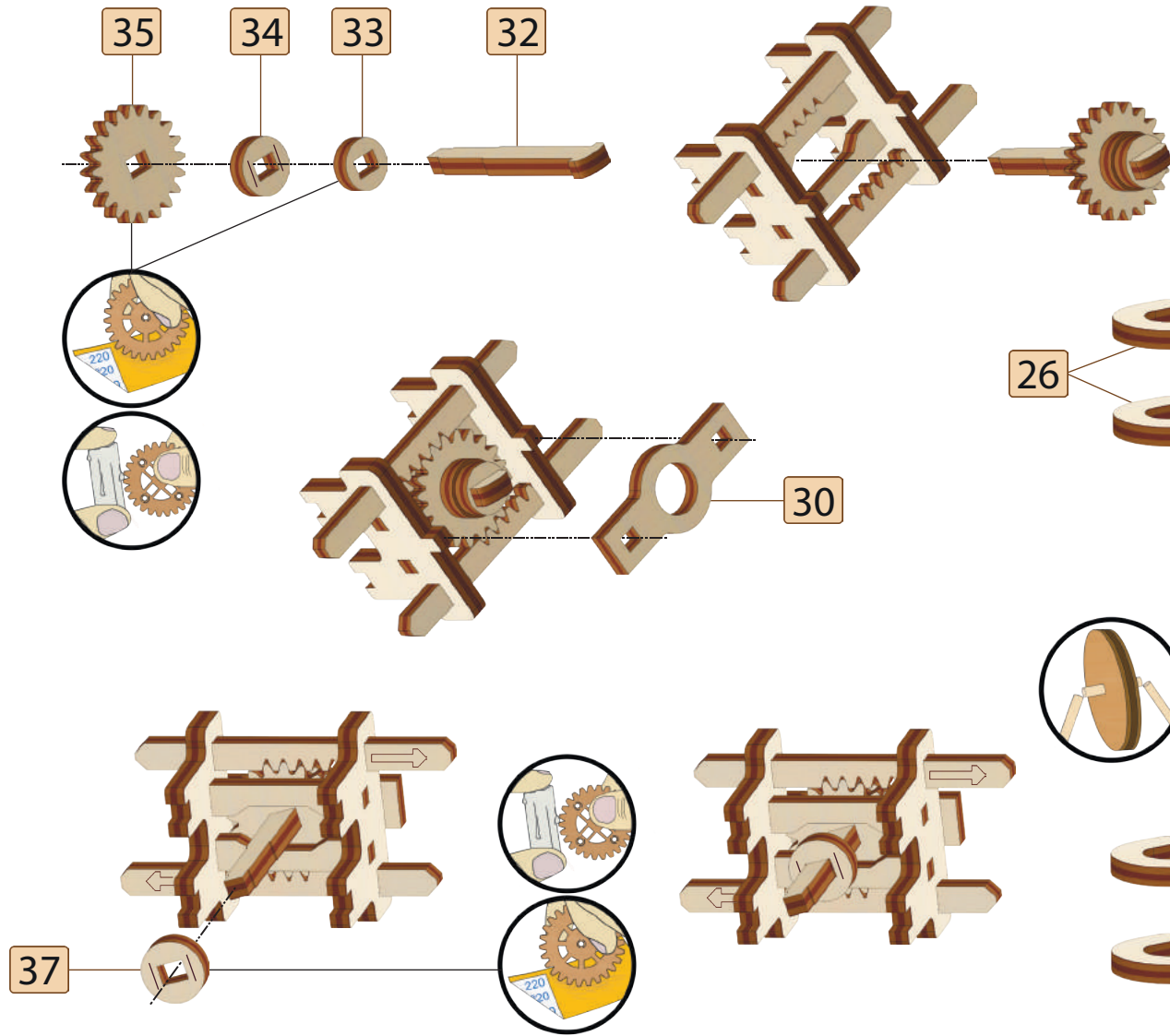
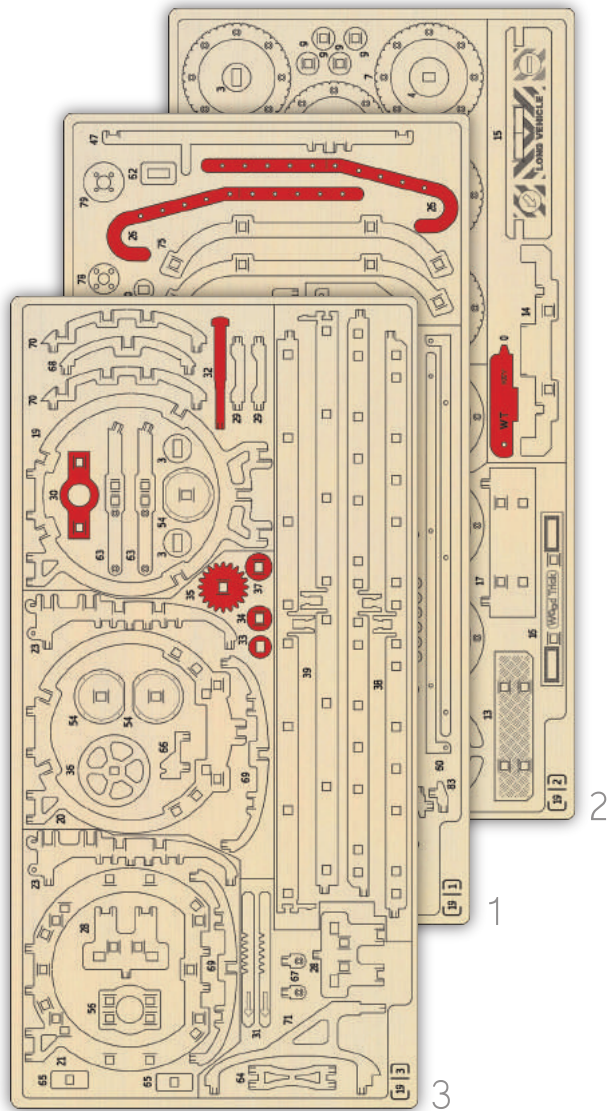

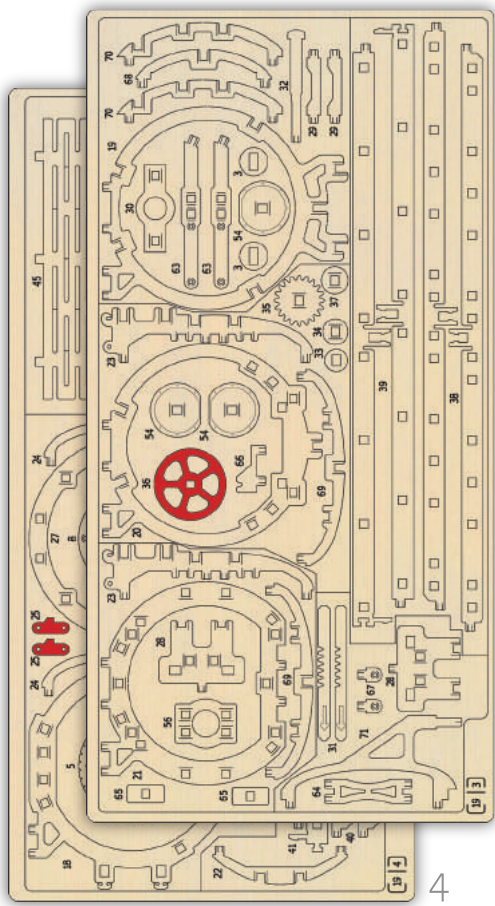

3

4

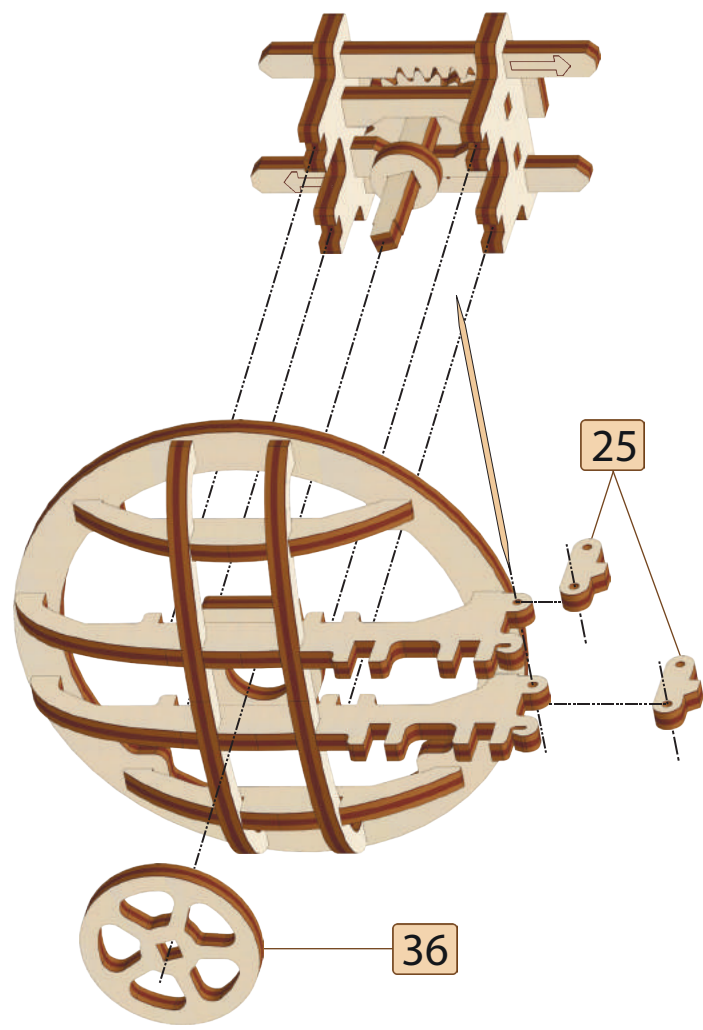

25

36

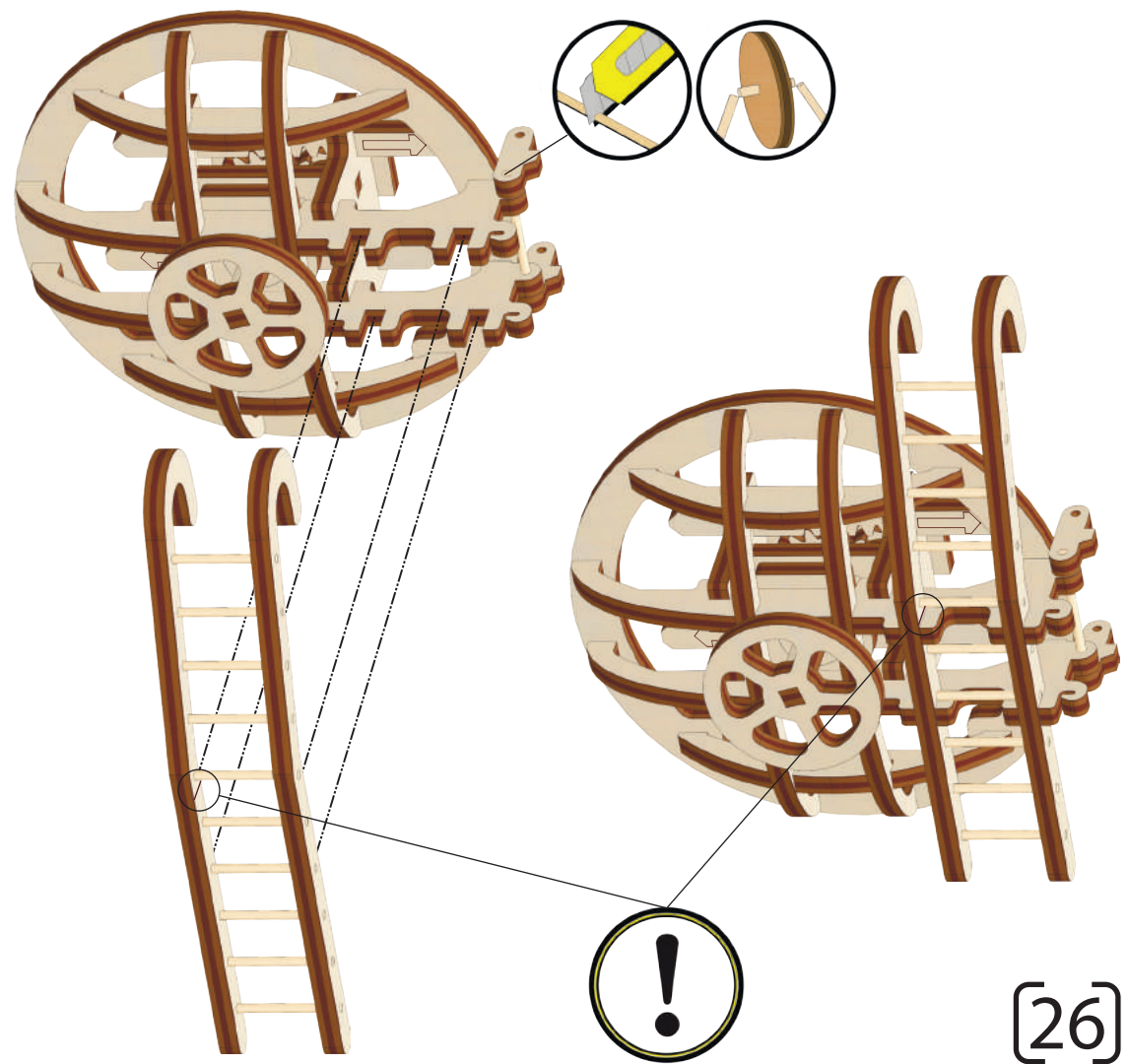

[26]

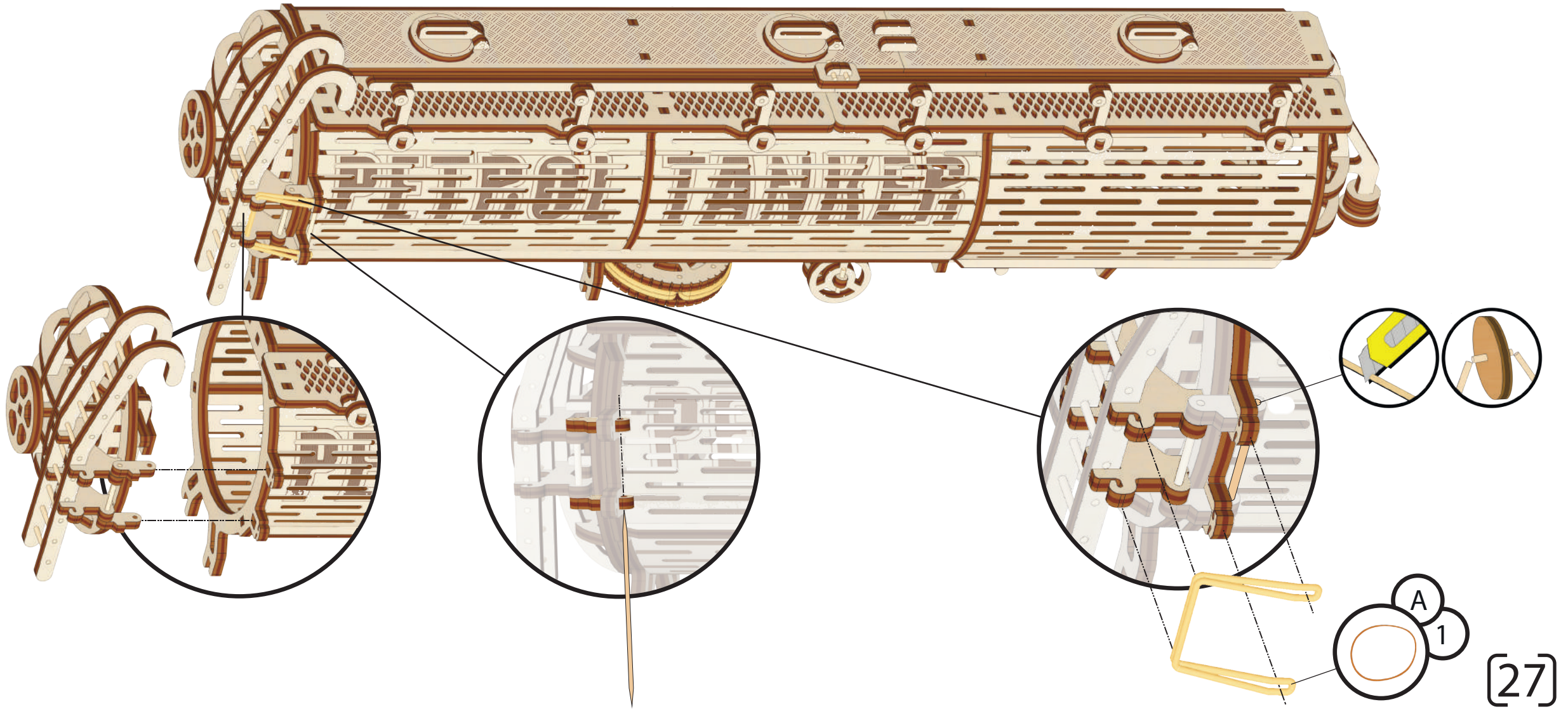

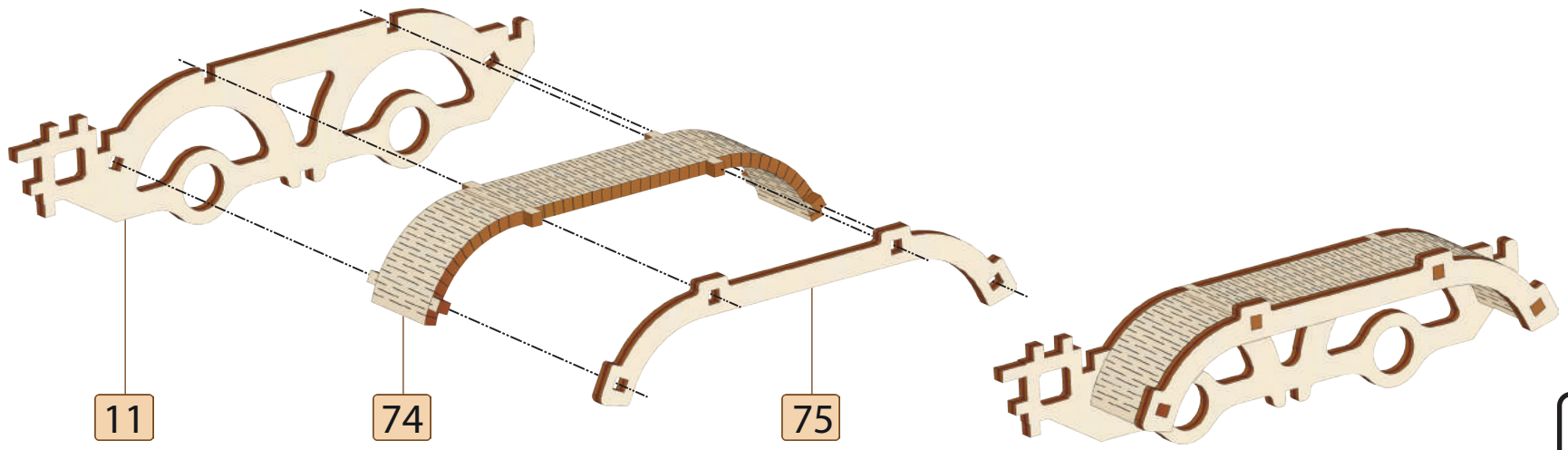
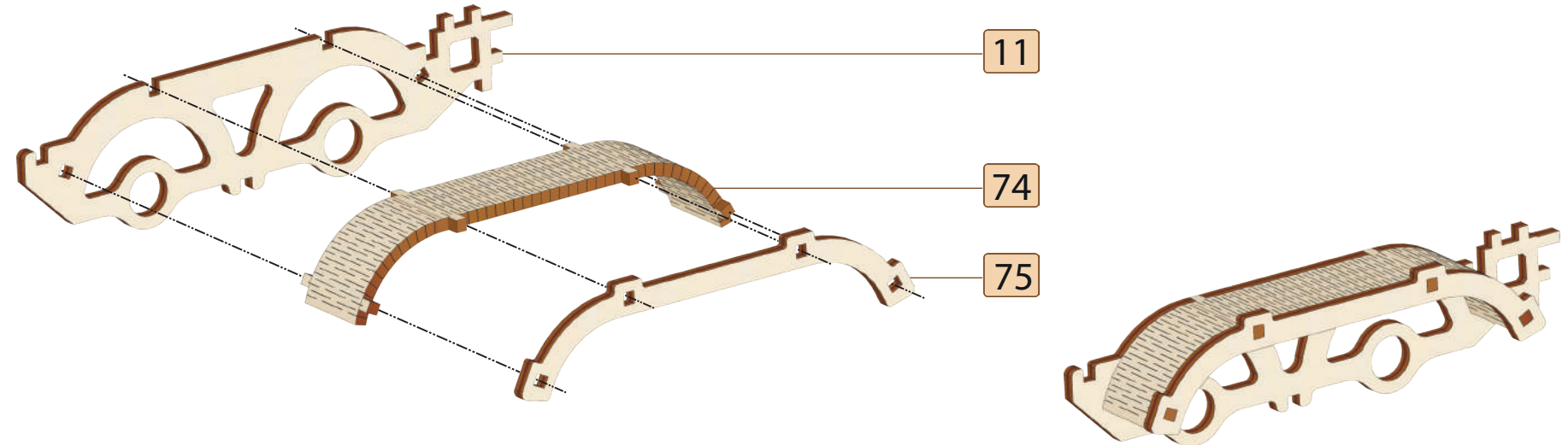
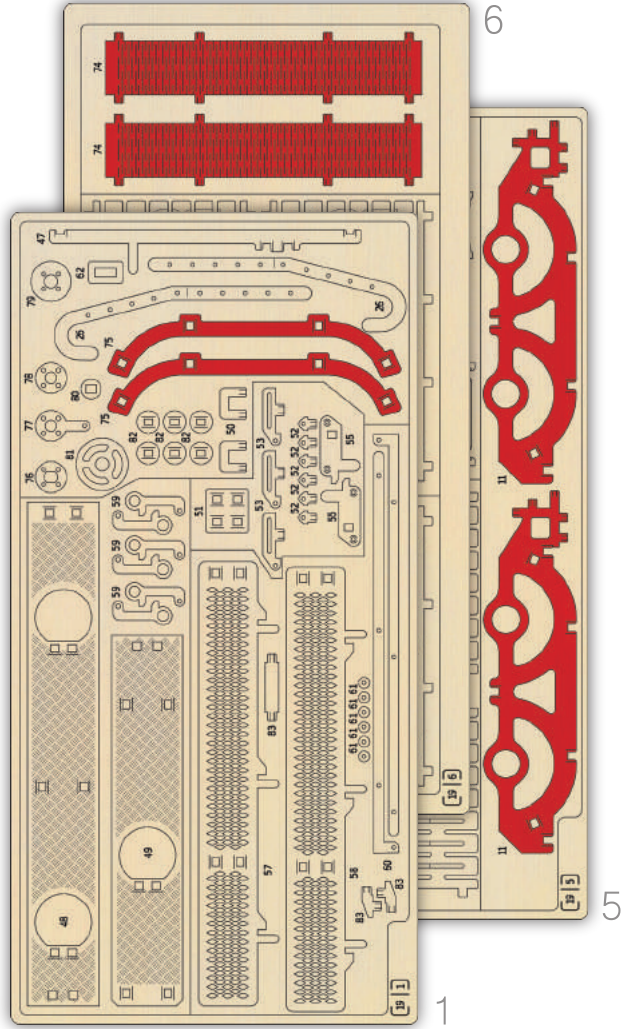

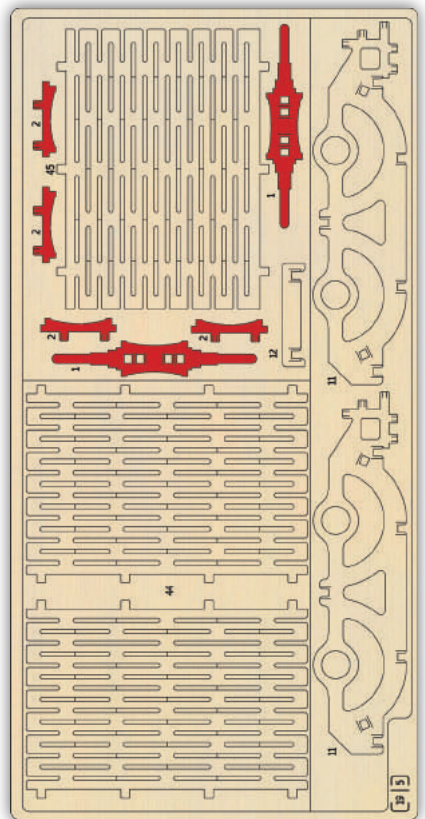

5

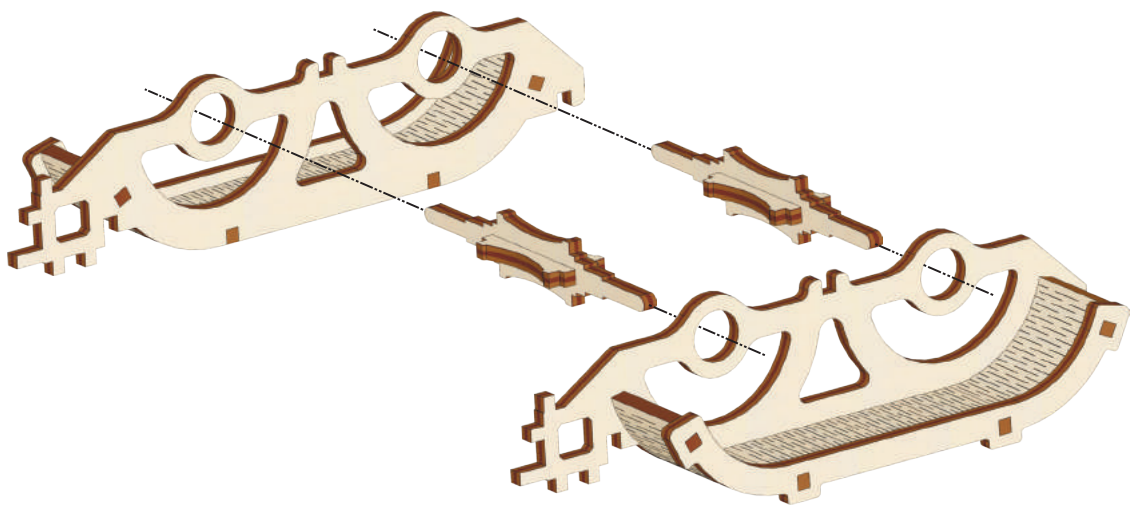
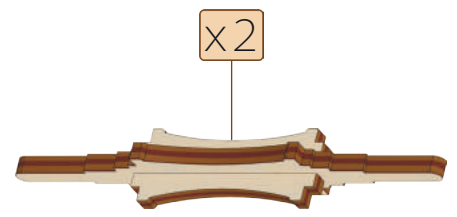
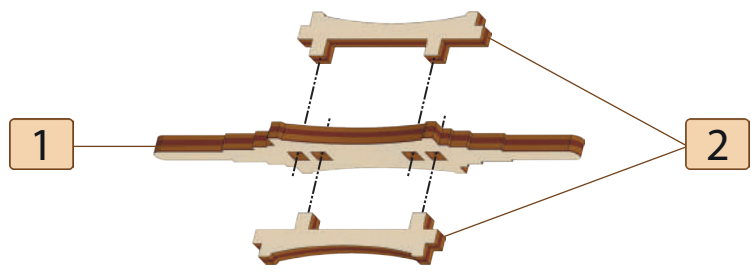

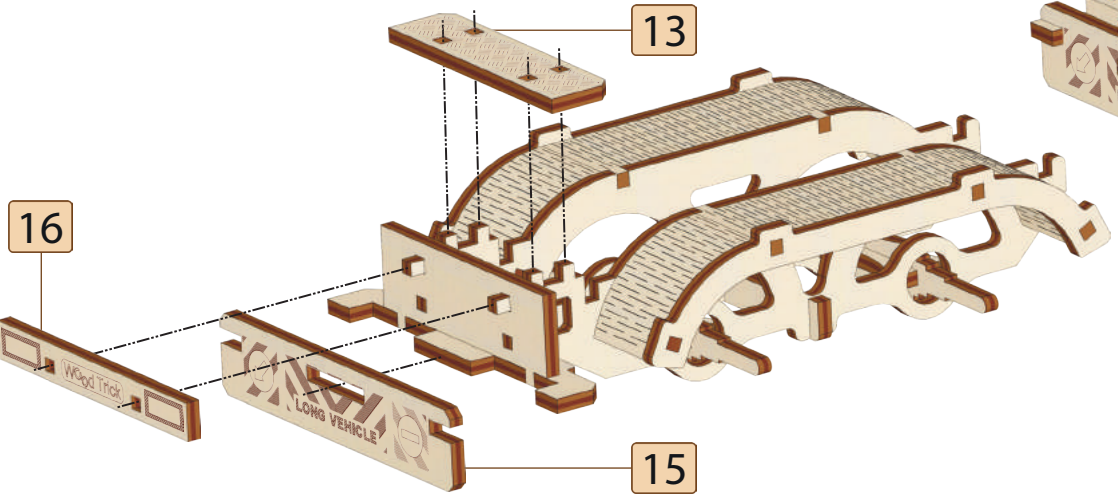
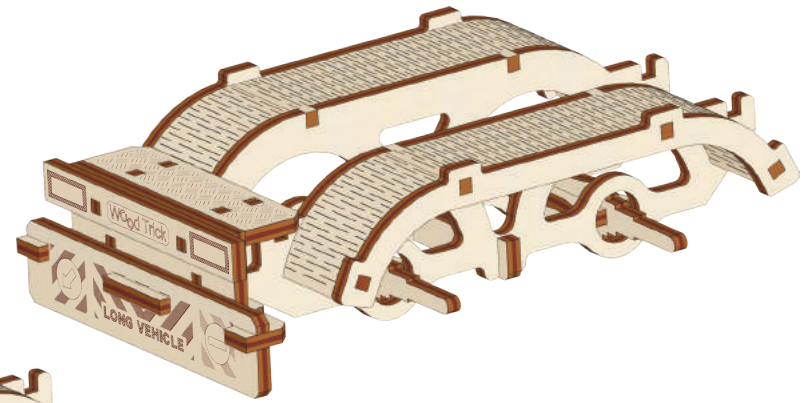
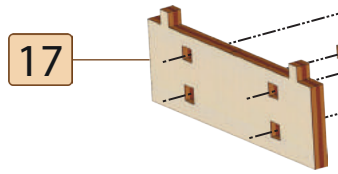
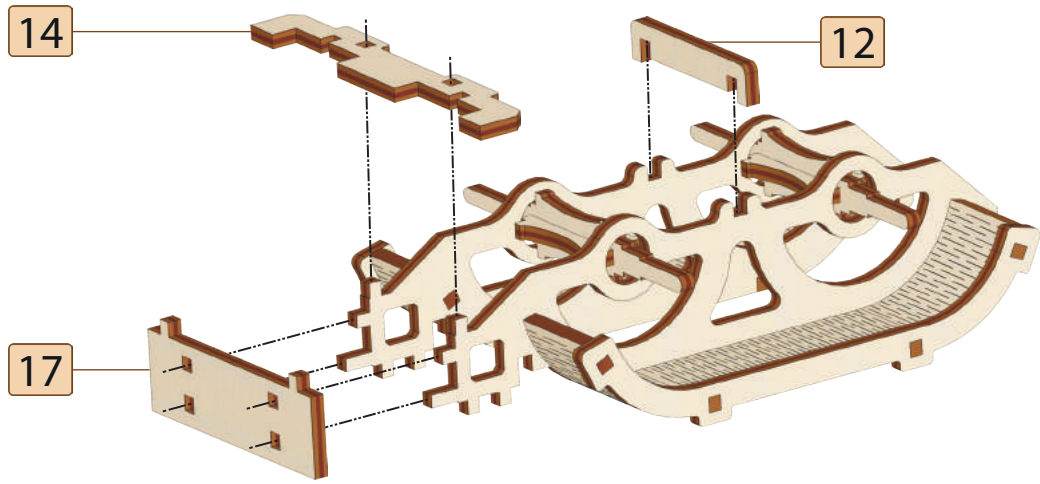
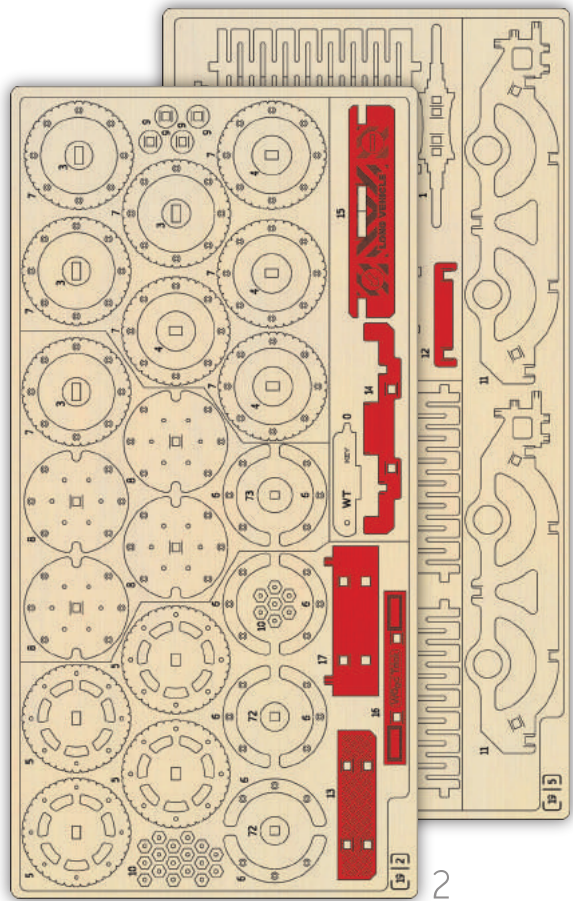

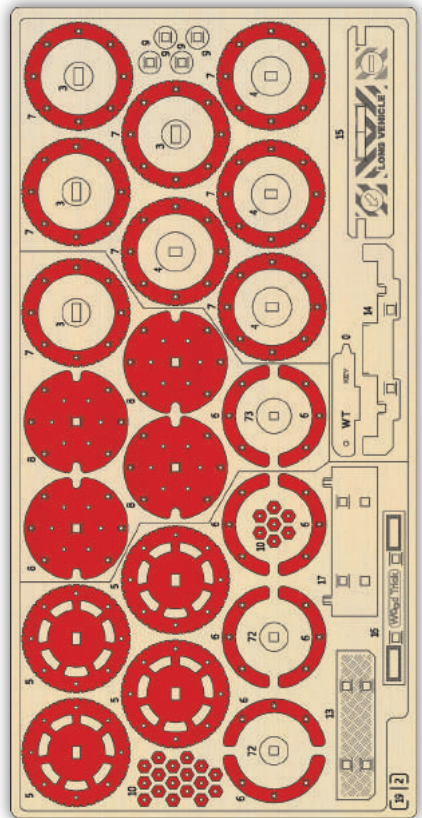

2

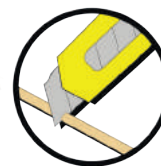
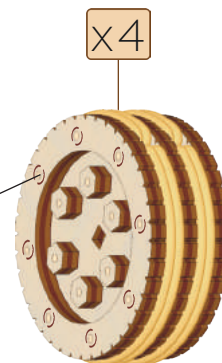
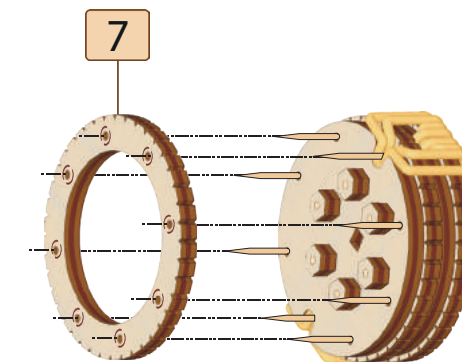
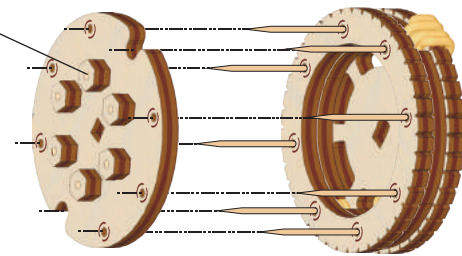
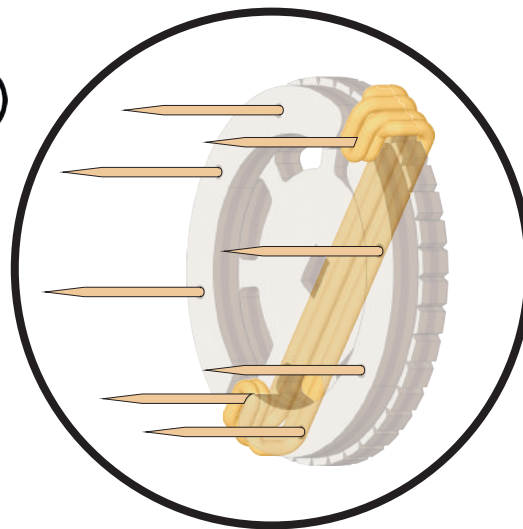
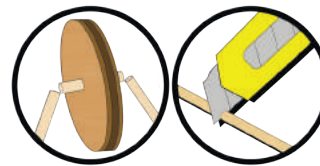
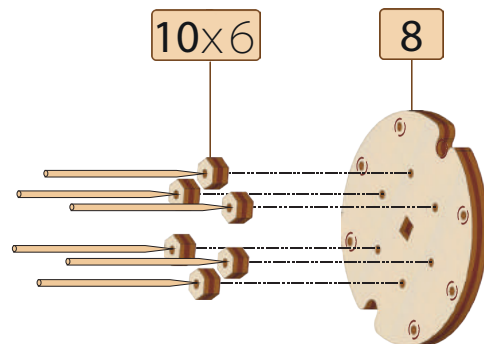
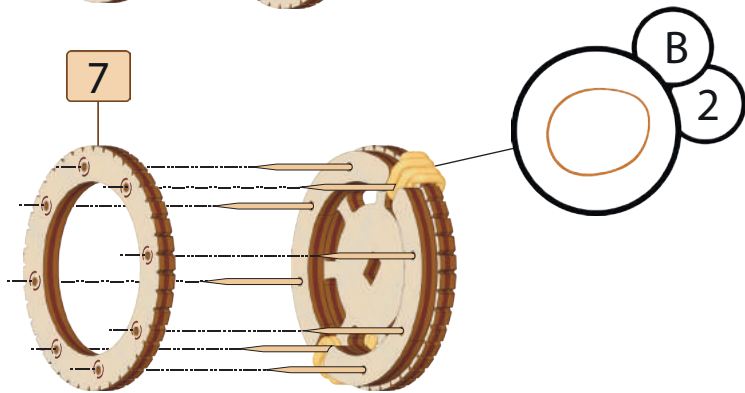
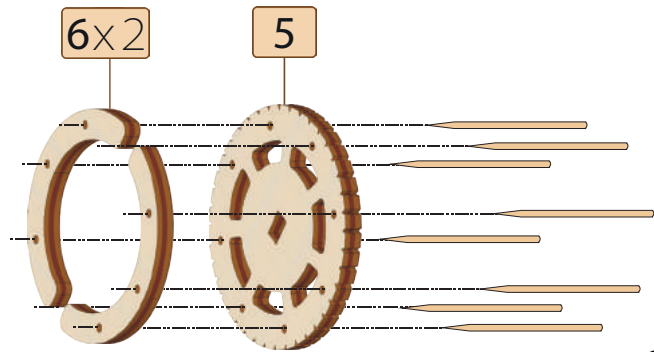

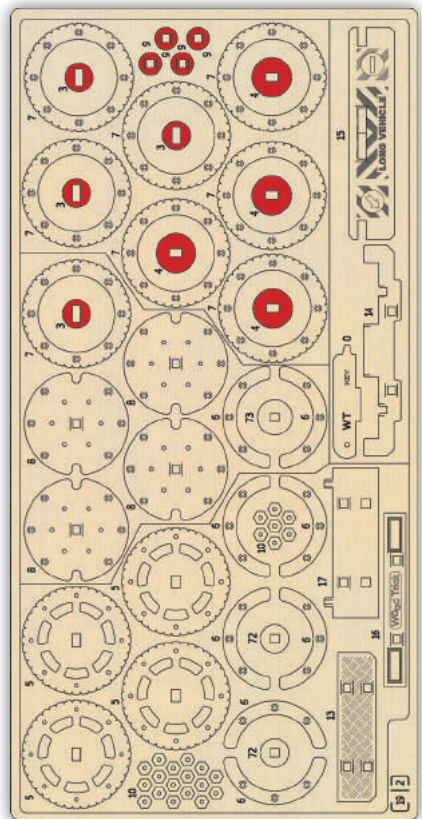

2

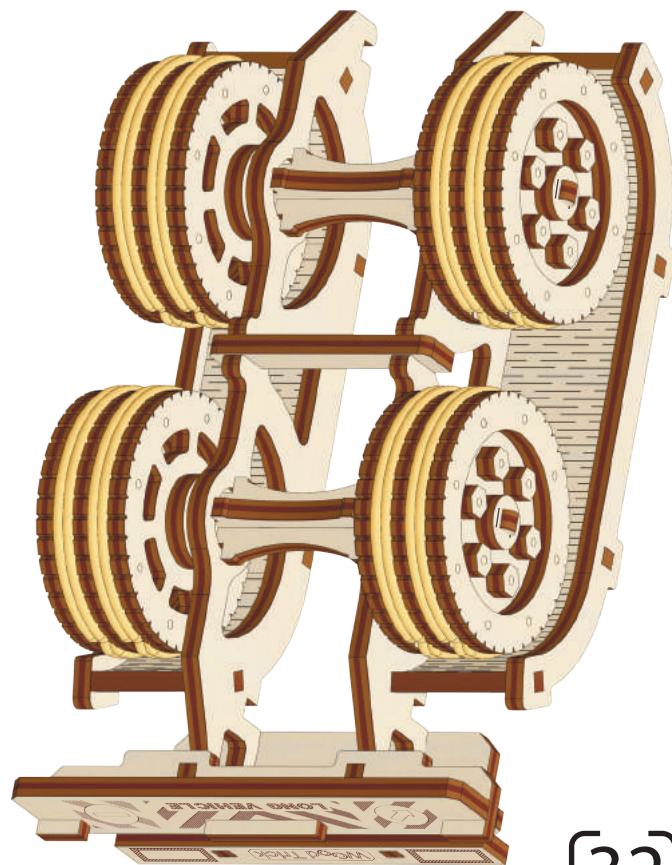
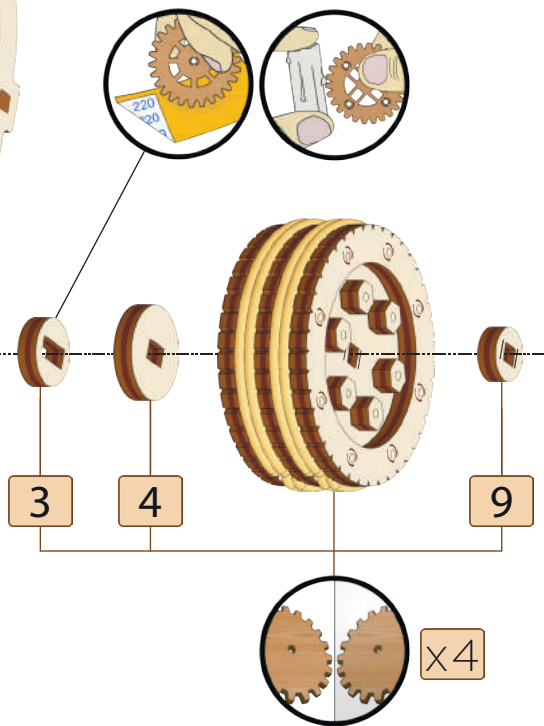
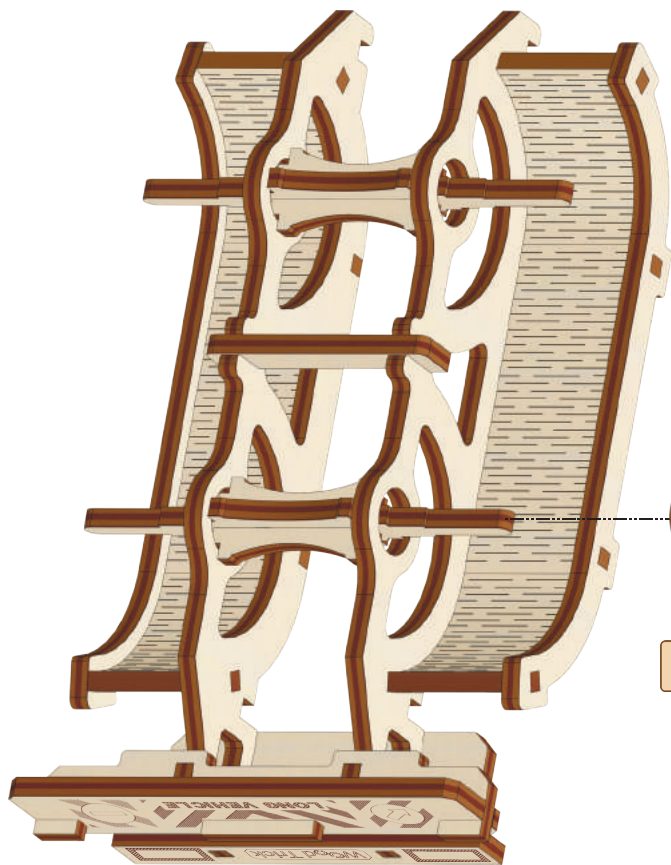

[32]

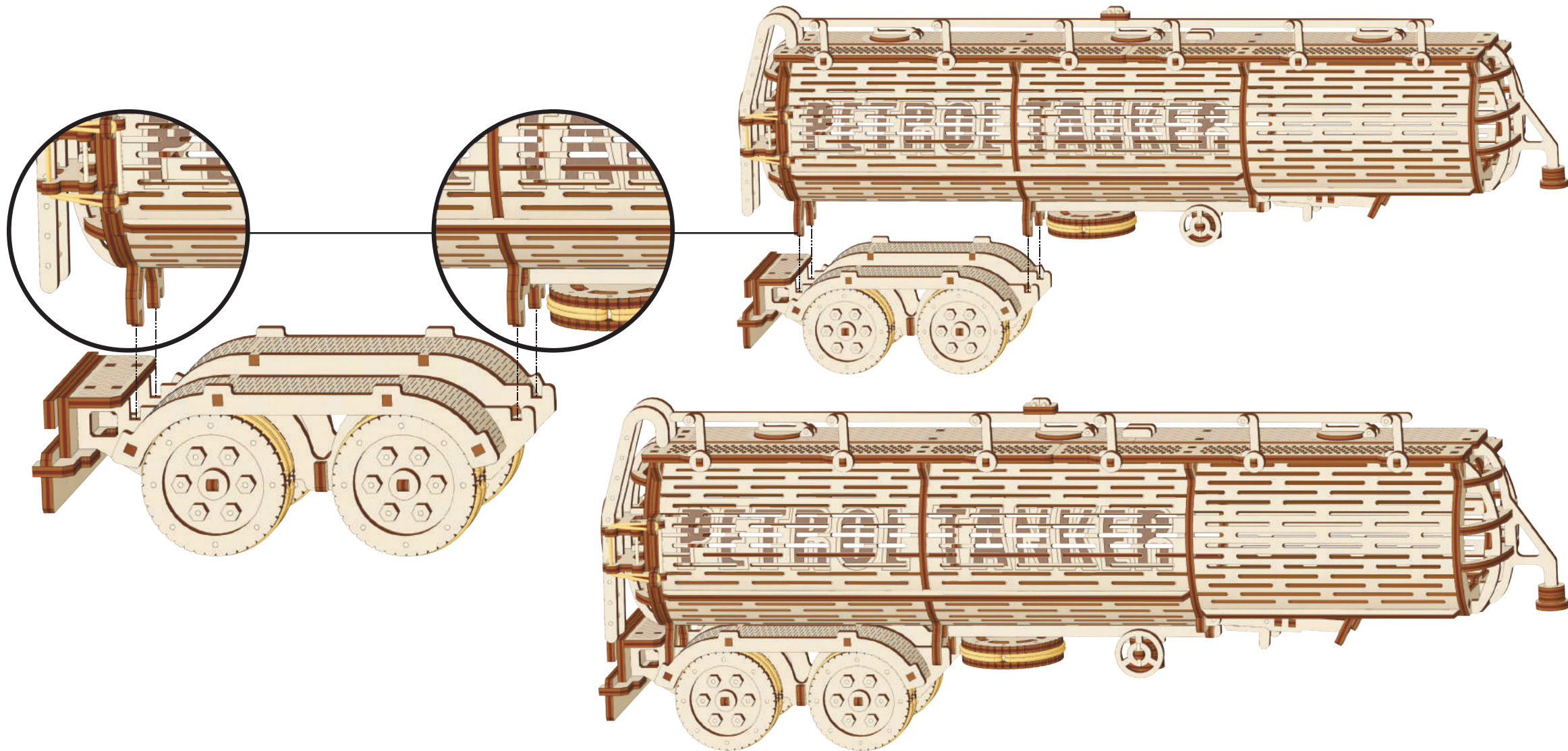

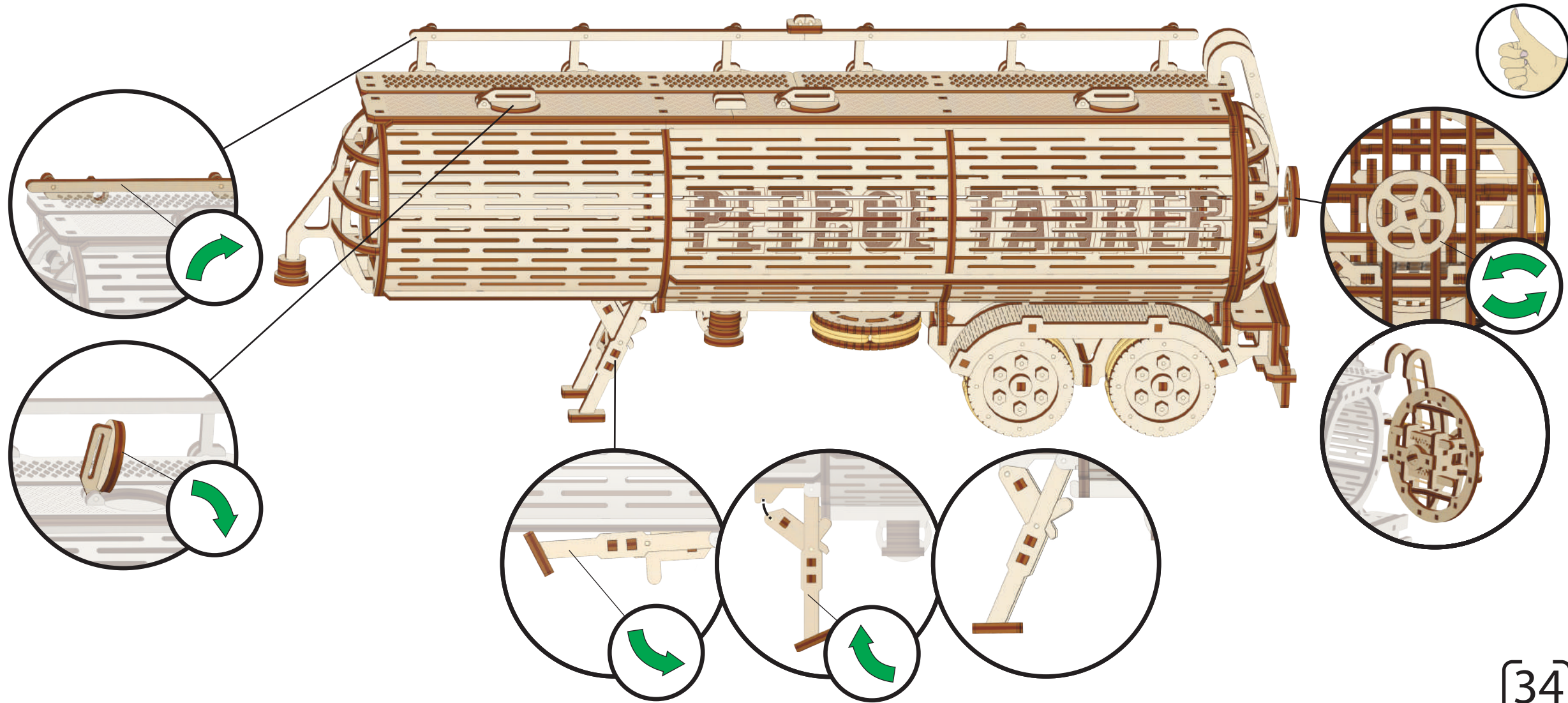



COLLECT A SET OF ADDITIONS

