



MR. PLAY WOOD

GIFT FOR
GIFTED

125
ДЕТАЛІ
PARTS

ІНСТРУКЦІЯ
USER GUIDE

Глобус "S" Globe "S"

NAME

Механічний конструктор із дерева

TYPE



WOOD
CONSTRUCTION
TOY



14+

15 CM



EDUCATIONAL
TOY



MR. PLAY
WOOD

MR. PLAY
WOOD

SPECIFICATIONS

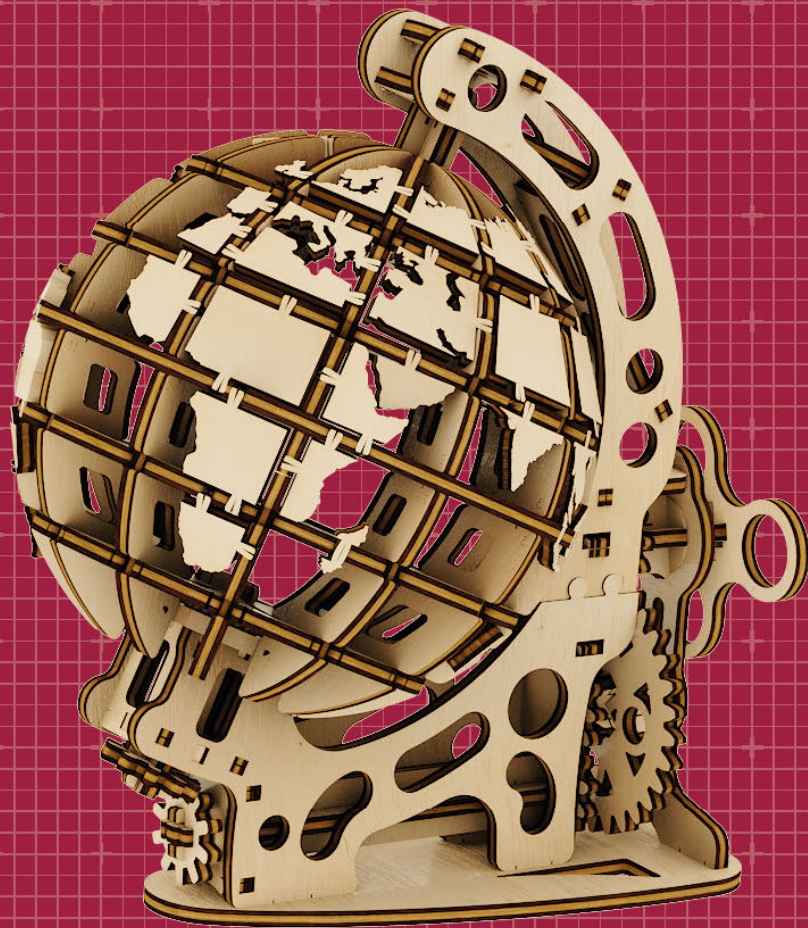

 **MR.PLAYWOOD**

ІНСТРУКЦІЯ ПО ВИКОРИСТАННЮ UKR. У ВАШИХ РУКАХ ЧАРІВНИЙ МЕХАНІЧНИЙ КОНСТРУКТОР ВІД MR.PLAYWOOD. ЙОГО НЕОБХІДНО ЗІБРАТИ З ДЕТАЛЕЙ, ЯКІ ВІД'ЄДНУЮТЬСЯ З ПЛАНШЕТІВ І ЗБИРАЮТЬСЯ БЕЗ КЛІЮ. ВСЕ, ЩО ВАМ НЕОБХІДНО ДЛЯ ЦЬОГО, Є В КОРОБЦІ. ВИКОРИСТОВУЙТЕ ВІСК ДЛЯ ПОЛПІЩЕННЯ КОВЗАННЯ ДЕТАЛЕЙ МЕХАНІЗМІВ І ЛЕГКОЇ СТИКОВКИ ДРІБНИХ ДЕТАЛЕЙ. ВИКОНУЙТЕ ЗБІРКУ ВІДПОВІДНО З ІНСТРУКЦІЄЮ. ДЛЯ СПРОЩЕННЯ ЗБІРКИ У КОЖНОМУ КОНСТРУКТОРІ ЗАПРОПОНОВАНО УНІВЕРСАЛЬНИЙ ІНСТРУМЕНТ. ВИКОРИСТОВУЙТЕ ЙОГО ДЛЯ ВІД'ЄДНАННЯ ДЕТАЛЕЙ З ПЛАНШЕТІВ, ОДЯГАННЯ ШЕСТИРЕНЬ НА ОСІ І ВИМІРЮВАННЯ ДОВЖИНИ.

INSTRUCTIONS FOR USE ENG. IN YOUR HANDS IS A CHARMING MECHANICAL CONSTRUCTION KIT FROM MR.PLAYWOOD. IT MUST BE ASSEMBLED FROM PARTS THAT ARE DISCONNECTED FROM TABLES AND GOING WITHOUT GLUE. ALL YOU NEED FOR THIS IS IN THE BOX. USE WAX TO IMPROVE THE SLIDING OF PARTS OF MECHANISMS AND LIGHT DOCKING OF SMALL PARTS. FOLLOW THE ASSEMBLY ACCORDING TO THE INSTRUCTIONS. IN ORDER TO SIMPLIFY THE ASSEMBLY IN EACH CONSTRUCTION KIT, A UNIVERSAL TOOL IS PROPOSED. USE IT TO DETACH PARTS FROM TABLES, DRESS GEARS ON THE AXIS AND MEASURE THE LENGTH.

MODE D'EMPLOI FRA ENTRE VOS MAINS SE TROUVE UN CHARMANT KIT DE CONSTRUCTION DE MR.PLAYWOOD. IL DOIT ETRE ASSEMBLER A PARTIR DE PIECES DECONNECTEES DES TABLES ET SE DEROULANT SANS COLLE. TOUT CE DONT VOUS AVEZ BESOIN EST DANS LA BOTTE. UTILISEZ LE LIBRIFIANT (CIRE) POUR AMÉLIORER LE GLISSEMENT DES AMARRAGES LEGER DES PETITES PIÈCES. SUIVRE L'ASSEMBLAGE EN FONCTION DES INSTRUCTIONS. POUR SIMPLIFIER L'ASSEMBLAGE DE CHAQUE KIT DE CONSTRUCTION, UN OUTIL EST PROPOSÉ. UTILISEZ LES MORCEAUX DE TABLE POUR VOUS, PUIS LES ENVELOPPER ET LES MESURER.

GEBRAUCHSANWEISUNG. DE IN IHREN HÄNDEN LIEGT EIN MAGISCHES MECHANISCHES SET VON MR.PLAYWOOD. ES MUSS VON TEILEN GESAMMELT WERDEN, DIE SICH VON DEN TABLETTEN LÖSEN UND OHNE KLEBSTOFF GESAMMELT WERDEN. ALLES WAS SIE DAFÜR BRAUCHEN, IST IN DER BOX. VERWENDEN SIE WACHS, UM DAS GLEITEN VON TEILEN DER MECHANISMEN UND DAS LEICHTE ANDÖCKEN VON KLEINTEILEN ZU VERBESSERN. FÜHREN SIE DIE MONTAGE GEMÄß DEN ANWEISUNGEN DURCH. UM DIE MONTAGE EINES JEDEN SATZES VORGESCHLAGEN UNIVERSALWERKZEUG ZU VEREINFACHEN. VERWENDEN SIE ES, UM TEILE VON TABLETTEN ZU LÖSEN, ZAHNRÄDER AUF DER ACHSE ANZUZIEHEN UND DIE LÄNGE ZU MESSEN.

INSTRUCCIONES DE USO. SPA EN TUS MANOS HAY UN ENCANTADOR MECANO DE MR.PLAYWOOD. DEBE MONTARSE A PARTIR DE PIEZAS QUE ESTÁN DESCONECTADAS DE LAS MESAS Y QUE VAN SIN COLA. TODO LO QUE NECESITAS PARA ESTO ESTÁ EN LA CAJA. UTILICE CERA PARA MEJORAR EL DESLIZAMIENTO DE LAS PIEZAS DE LOS MECANISMOS Y EL FÁCIL ACOPLAMIENTO DE LAS PIEZAS PEQUEÑAS. SIGA LAS INSTRUCCIONES DE ENSAMBLAJE. PARA SIMPLIFICAR EL MONTAJE EN CADA CONJUNTO OFRECE UNA HERRAMIENTA UNIVERSAL. ÚSELO PARA SEPARAR PARTES DE LAS TABLETAS, ADEREZAR LOS ENGRANAJES EN EL EJE Y MEDIR LA LONGTUD.

ISTRUZIONI PER L'USO. ITA NELLE TUE MANI C'È UN SET MECCANICO MAGICO DI MR.PLAYWOOD. DEVE ESSERE RACCOLTO DA PARTI STACCATO DALLE TAVOLETTE E RACCOLTE SENZA COLLA. TUTTO CIÒ CHE SERVE PER QUESTO È NELLA SCATOLA. UTILIZZARE LA CERA PER MIGLIORARE LO SCORRIMENTO DI PARTI DI MECCANISMI E L'ATTRACCO LEGGERO DI PICCOLE PARTI. ESEGUIRE IL MONTAGGIO SECONDO LE ISTRUZIONI. AL FINE DI SEMPLIFICARE L'ASSEMBLAGGIO IN OGNI SET OFFRE UNO STRUMENTO UNIVERSALE. USALO PER STACCARE PARTI DA COMPRESSE, VESTIRE GLI INGRANAGGI SULL'ASSE E MISURARE LA LUNGHEZZA.

UA. ОБЕРЕЖНО! МАТЕРІАЛ КОНСТРУКТОРА – ДЕРЕВО, МОЖЛИВІ МІКРОТРИЩИНИ. ВИКОРИСТОВУЙТЕ ІНСТРУМЕНТ, АБИ УНИКНУТИ РОЗЛОМУ ДЕТАЛЕЙ ПРИ ВИДАЛЕННІ ЇХ З ПЛАНШЕТУ. EN. CAREFULLY! PRODUCT MATERIAL – WOOD, POSSIBLE MICROCRACKS. USE THE TOOL TO AVOID FRACTURING DETAILS WHEN REMOVING THEM FROM THE TABLE. FRA. ATTENTION! LE MATÉRIAU DE CONCEPTION PEUT PROVOQUER DES MICROFISSURES. UTILISEZ L'OUTIL POUR ÉVITER DE FRACTURER LES DÉTAILS LORSQUE VOUS LES RETIREZ DE LA TABLE. DE. SEI VORSICHTIG! MATERIAL-SETS – HOLZ, SIND RISSE MÖGLICH. VERWENDEN SIE DAS TOOL BRUCH VON TEILEN ZU VERMEIDEN, WENN SIE AUS DER TABLETTE ZU ENTFERNEN. SPA. ¡PRECAUCIÓN! MATERIAL DE UN PRODUCTO – DE MADERA, POSIBLES MICROCRACKS. UTILICE LA HERRAMIENTA PARA EVITAR LA FRACTURA DE LAS PIEZAS AL SACARLOS DE LA TABLET. ITA. STAI ATTENTO! SET MATERIALE – IL LEGNO, LE CREPE SONO POSSIBILI. UTILIZZARE LO STRUMENTO PER EVITARE DETTAGLI DI FRATTURA DURANTE LA RIMOZIONE DAL TABLET.

UA. ІНСТРУМЕНТ. EN. TOOL. FRA. INSTRUMENTS. DE. WERKZEUG. SPA. LA HERRAMIENTA. ITA. STRUMENTO.

UA. ЗАПАСНІ ДЕТАЛІ. EN. SPARE PARTS. FRA. PIÈCES DE RECHANGE. DE. ERSATZTEILE. SPA. PIEZAS DE REPUESTO. ITA. PEZZI DI RICAMBIO.





MR.
PLAY
WOOD

GIFT FOR
GIFTED

UKR. УВАГА! ЗВЕРНІТЬ УВАГУ НА УМОВНІ ПОЗНАЧЕННЯ ІНСТРУКЦІЇ **ENG.** CAUTION! TAKE A NOTE OF GUIDE LEGEND **DEU.** ACHTUNG! BEACHTEN SIE DIE KURZZEICHEN IN DER GEBRAUCHSANWEISUNG **FRA.** ATTENTION! VEUILLEZ RESPECTER LES CONSEILS D'UTILISATIONS PRÉSENTÉS PAR LES PICTOGRAMMES

SPA. ¡ATENCIÓN! PRESTE ATENCIÓN A LOS SÍMBOLOS DE LA GUÍA



UA. ЗМАЩУЙТЕ ДЕТАЛІ ВОСКОМ. **EN.** LUBRICATE PARTS WITH WAX. **FRA.** LUBRIFIEZ LES DÉTAILS AVEC LA CIRE. **DE.** MIT WACHS AUF DIE DETAILS. **SPA.** LUBRIQUE LOS DETALLES CON CERA. **ITA.** LUBRIFICARE I DETTAGLI CON CERA.



UA. ОБОВ'ЯЗКОВО ЗМАСТИТИ ВОСКОМ ПО ХОДУ ПОМАРАНЧЕВОЇ ЛІНІЇ. **EN.** BE SURE TO WAX IN THE DIRECTION OF THE ORANGE LINE. **FRA.** ASSUREZ-VOUS DE LUBRIFIER DANS LE SENS DE LA LIGNE ORANGE. **DE.** ACHTEN SIE DARAUF, WACHS IN RICHTUNG DER ORANGEFARBENE LINIE. **SPA.** ASEGÚRESE DE CERA EN LA DIRECCIÓN DE LA LÍNEA NARANJA. **ITA.** ASSICURARSI DI CERA IN DIREZIONE DELLA LINEA ARANCIONE.



UA. ЗВЕРНІТЬ УВАГУ. **EN.** PAY ATTENTION. **FRA.** FAITES ATTENTION. **DE.** PASST AUF. **SPA.** PRESTA ATENCIÓN. **ITA.** FAI ATTENZIONE.



UA. УВАГУ СЮДИ. **EN.** ATTENTION. **FRA.** ATTENTION. **DE.** BEACHTUNG. **SPA.** ATENCIÓN. **ITA.** ATTENZIONE.



UA. ЗБЕРІТЬ ДРУГИЙ ТАКИЙ ЖЕ ВУЗОЛ, ЗГІДНО З ІНСТРУКЦІЄЮ. **EN.** ASSEMBLE THE SECOND SUCH BLOCK IN ACCORDANCE WITH THE INSTRUCTIONS. **FRA.** ASSEMBLEZ LE DEUXIÈME BLOC CONFORMÉMENT AUX INSTRUCTIONS. **DE.** BAUEN SIE DEN ZWEITEN SOLCHEN BLOCK GEMÄß DEN ANWEISUNGEN ZUSAMMEN. **SPA.** MONTAR EL SEGUNDO BLOQUE DE ESTE TIPO DE ACUERDO CON LAS INSTRUCCIONES. **ITA.** ASSEMBLARE IL SECONDO BLOCCO DI QUESTO TIPO IN BASE ALLE ISTRUZIONI.



UA. РОЗМІР ДЕТАЛІ В ММ (1 ДЮЙМ = 25,4 ММ). **EN.** PART SIZE IN MM (1 INCH = 25.4MM). **FRA.** TAILLE DE LA PIÈCE EN MM (1 POUCE = 25,4MM). **DE.** TEILEGRÖßE IN MM (1 ZOLL = 25,4 MM). **SPA.** TAMAÑO DE LA PIEZA EN MM (1 PULGADA = 25.4MM). **ITA.** PARTE DIMENSIONI IN MM (1 POLLICE = 25,4 MM).



**MR.
PLAY
WOOD**

**GIFT FOR
GIFTED**



UA. РОЗМІР ДЕТАЛІ В ММ (1 ДЮЙМ = 25,4 ММ). EN. PART SIZE IN MM (1 INCH = 25.4MM). FRA. TAILLE DE LA PIÈCE EN MM (1 POUCE = 25,4MM). DE. TEILEGRÖßE IN MM (1 ZOLL = 25,4 MM). SPA. TAMAÑO DE LA PIEZA EN MM (1 PULGADA = 25.4MM). ITA. PARTE DIMENSIONI IN MM (1 POLLICE = 25,4 MM).



UA. ЗДІЙСНИ ДІЮ. EN. DO THE ACTION. FRA. FAITES L'ACTION. DE. MACH DIE AKTION. SPA. REALIZAR LA ACCIÓN. ITA. FAI L'AZIONE.



UA. РЕЗУЛЬТАТ ДІЇ. EN. RESULT OF ACTION. FRA. RÉSULTAT DE L'ACTION. DE. DAS ERGEBNIS DER AKTION. SPA. EL RESULTADO DE LA ACCIÓN. ITA. IL RISULTATO DELL'AZIONE.



UA. ВСТАНОВИТИ ДЕТАЛЬ У ВКАЗАНЕ МІСЦЕ. EN. SET THE DETAIL TO THE SPECIFIED LOCATION. FRA. METTRE LE DÉTAIL À L'EMPLACEMENT SPÉCIFIÉ. DE. STELLEN SIE DAS DETAIL AUF DEN ANGEGEBENEN ORT EIN. SPA. ESTABLECER EL DETALLE EN LA UBICACIÓN ESPECIFICADA. ITA. IMPOSTARE DETTAGLIO ALLA POSIZIONE SPECIFICATA.



UA. ПОДИВИСЬ СЮДИ. EN. LOOK HERE. FRA. REGARDEZ ICI. DE. SCHAU HIER. SPA. MIRA AQUÍ. ITA. GUARDA QUI.



UA. ЗАПАСНІ ДЕТАЛІ. EN. SPARE PARTS. FRA. PIÈCES DE RECHANGE. DE. ERSATZTEILE. SPA. PIEZAS DE REPUESTO. ITA. PEZZI DI RICAMBIO.



UA. ІНСТРУМЕНТ. EN. TOOL. FRA. INSTRUMENTS. DE. WERKZEUG. SPA. LA HERRAMIENTA. ITA. STRUMENTO.



MR.
PLAY
WOOD

GIFT FOR
GIFTED

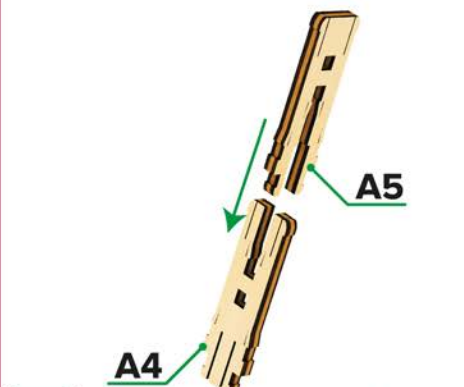

1.1

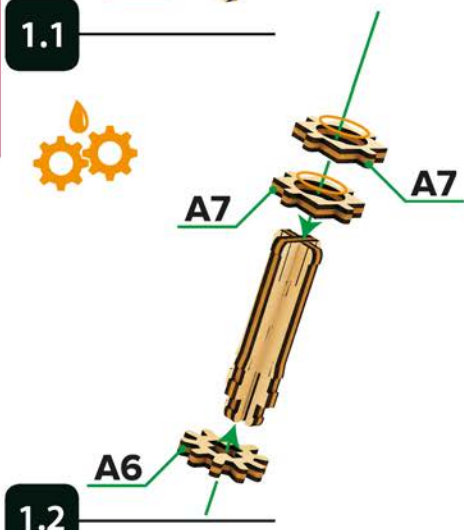

1.2



1.3

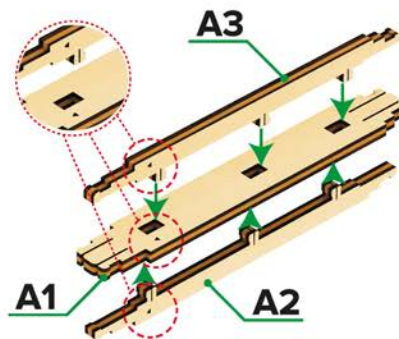
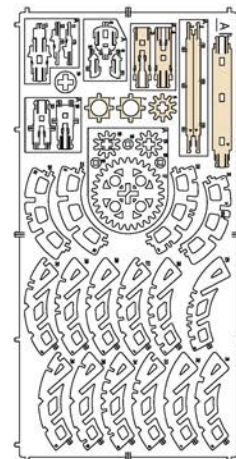

2.1



MR.
PLAY
WOOD

GIFT FOR
GIFTED

2.2

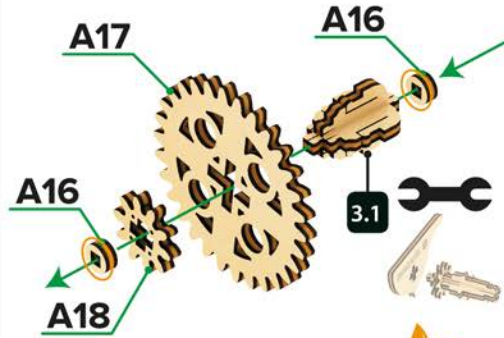
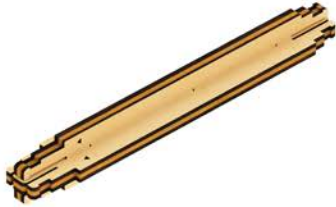

3.2

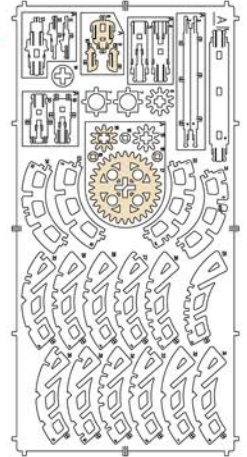

3.1

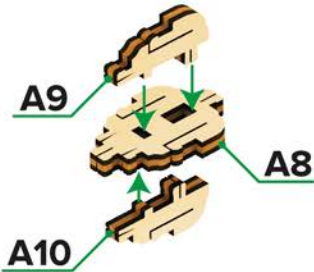

3.3



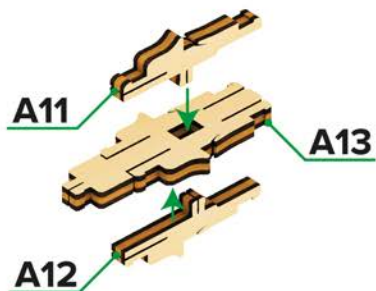

4.1

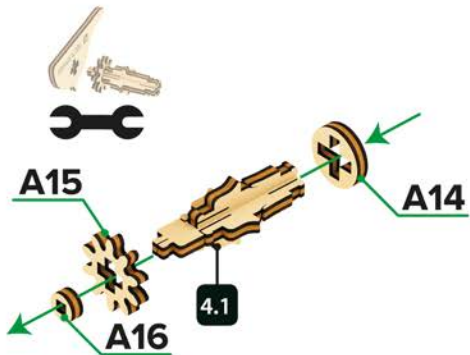

4.2



4.3

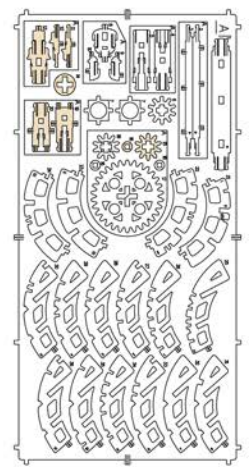

5.1

MR. PLAY WOOD

GIFT FOR
GIFTED

5.2



B37

6.1

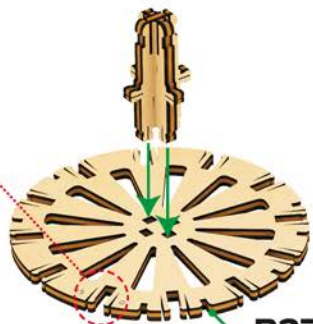

6.2

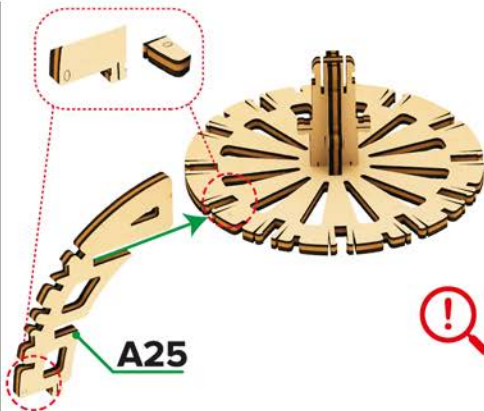

A25

6.3

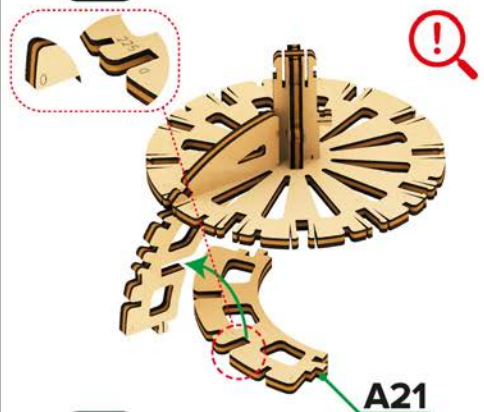

A21

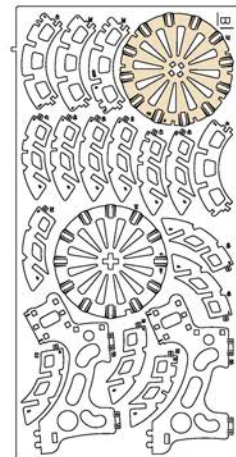
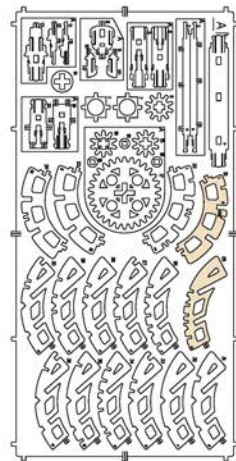

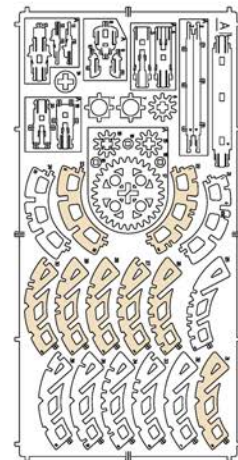
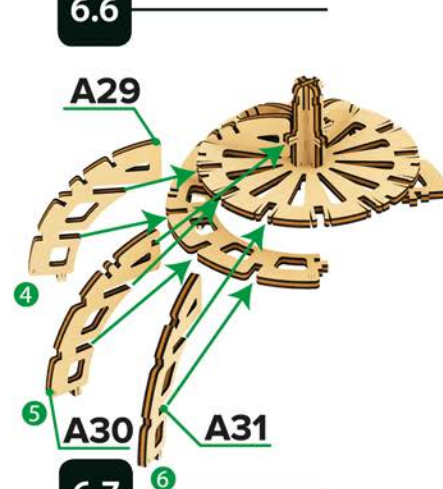
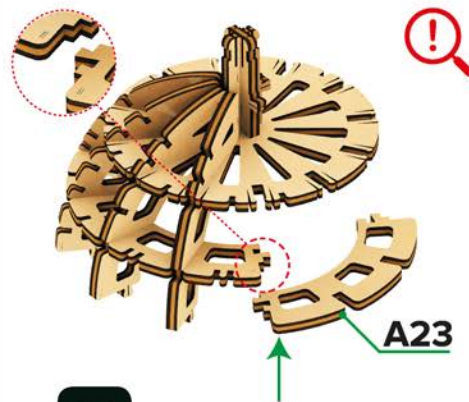
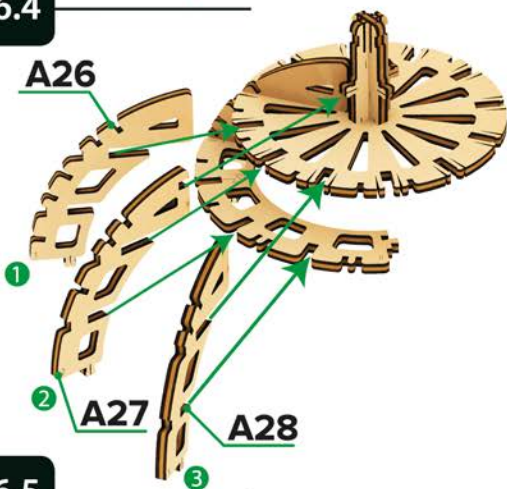
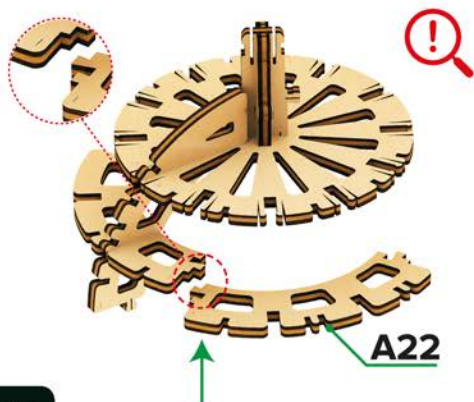

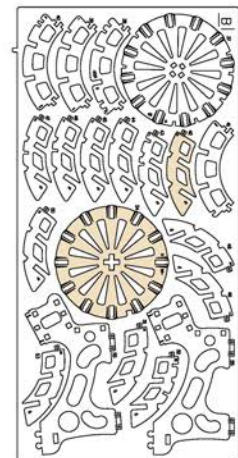
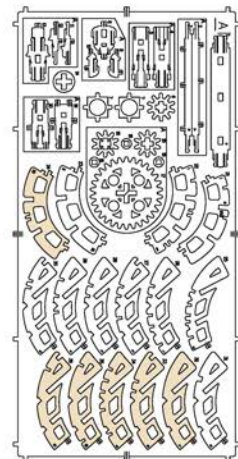
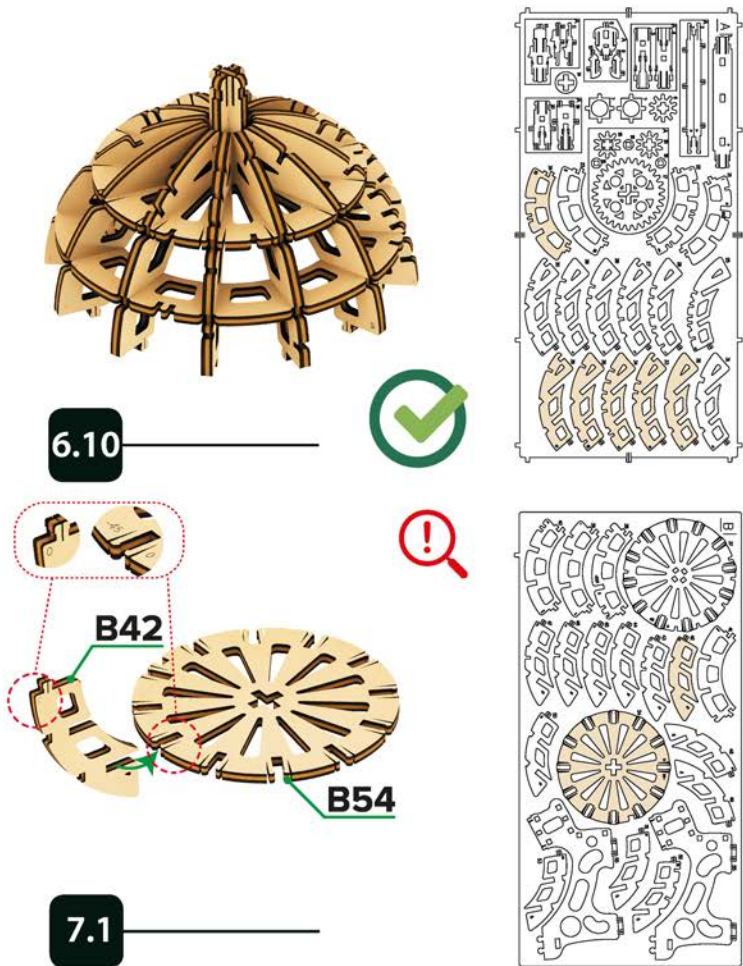
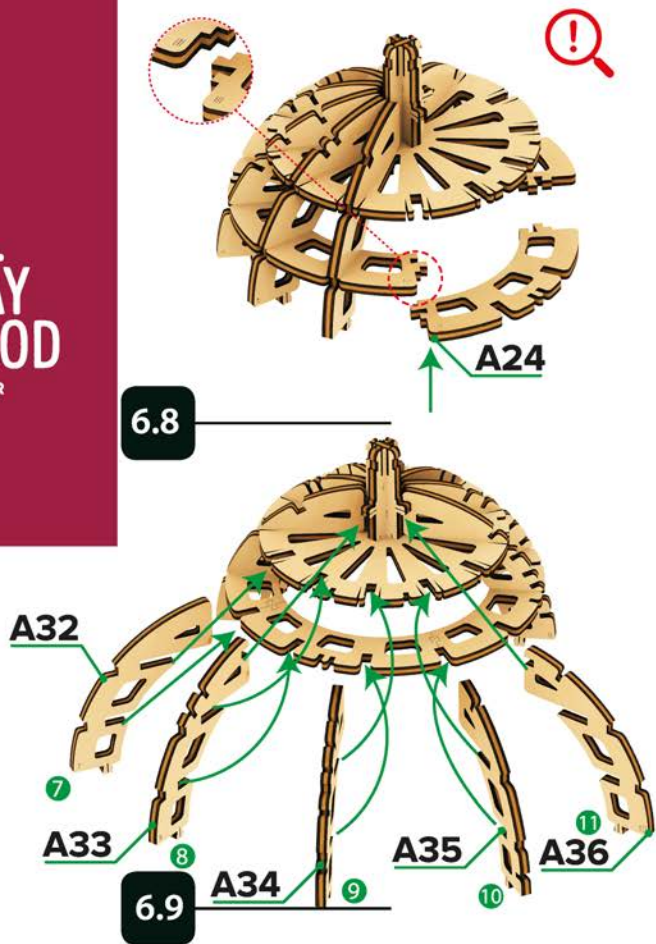

MR. PLAY WOOD

GIFT FOR
GIFTED

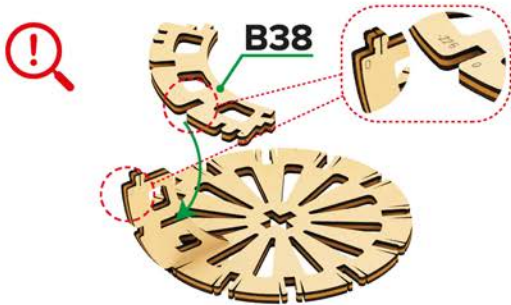

7.2

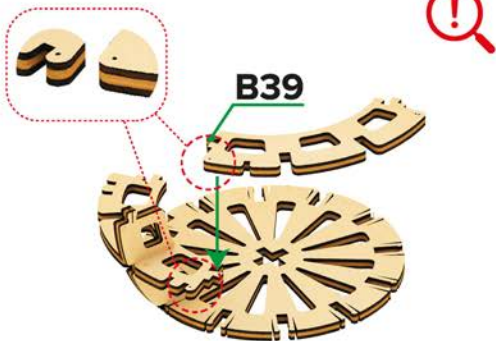

7.3

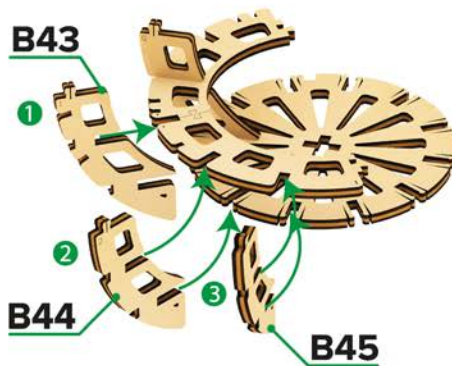

7.4



7.5

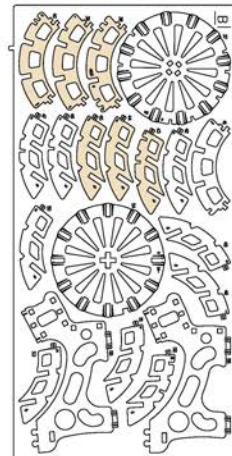



MR.
PLAY
WOOD

GIFT FOR
GIFTED

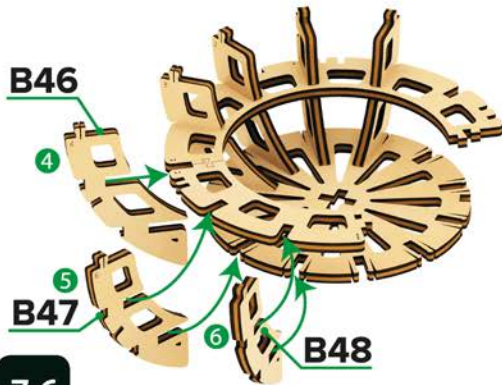

7.6

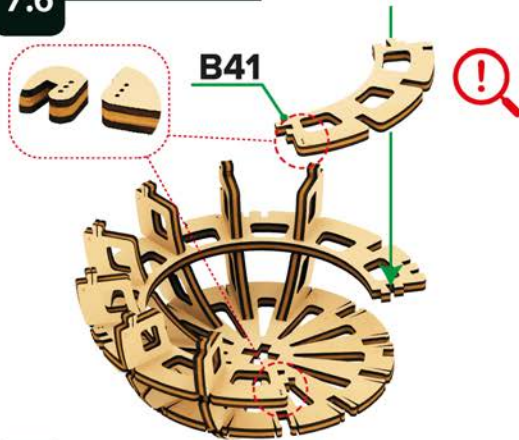

7.7

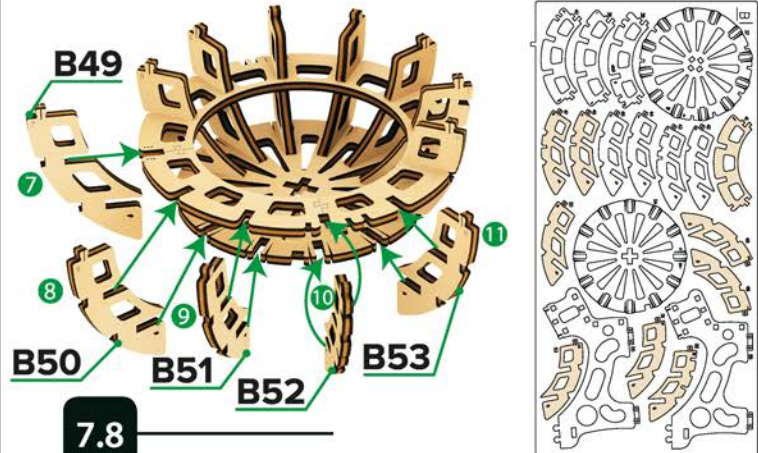

7.8



7.9

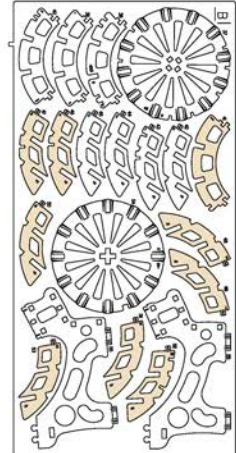



MR.
PLAY
WOOD

GIFT FOR
GIFTED

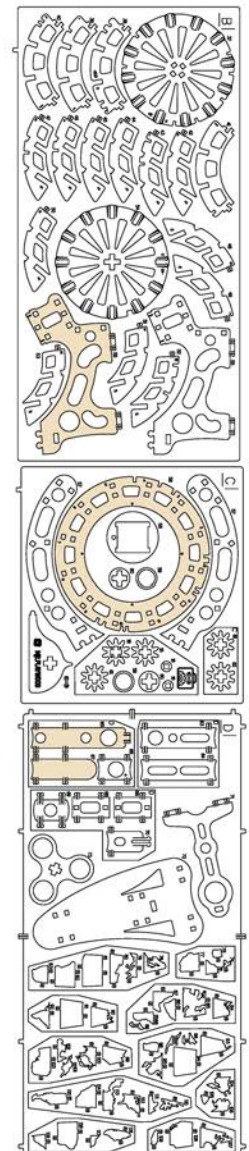
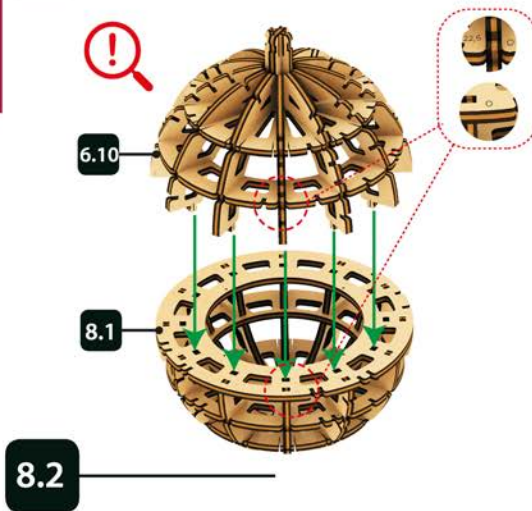
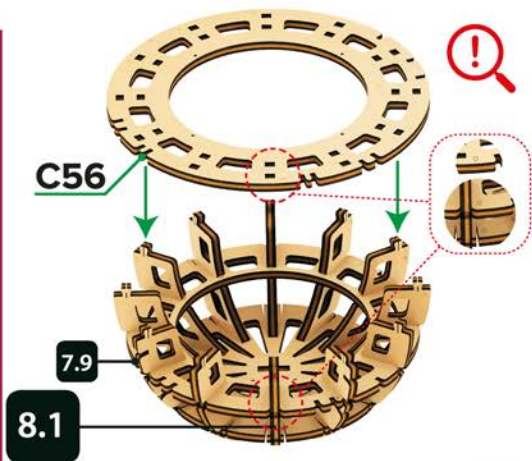



MR. PLAY WOOD

GIFT FOR GIFTED

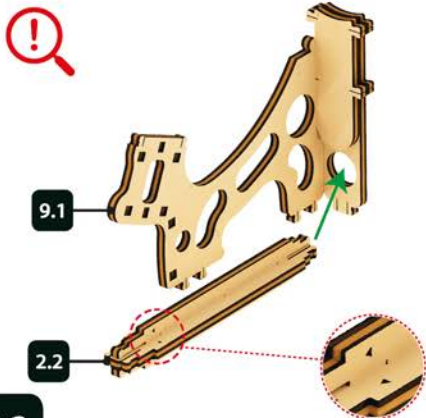

9.2

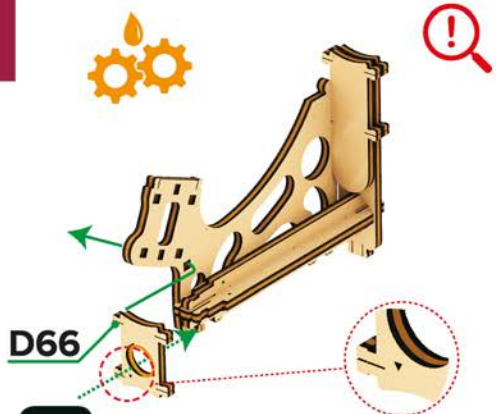

9.3



9.4

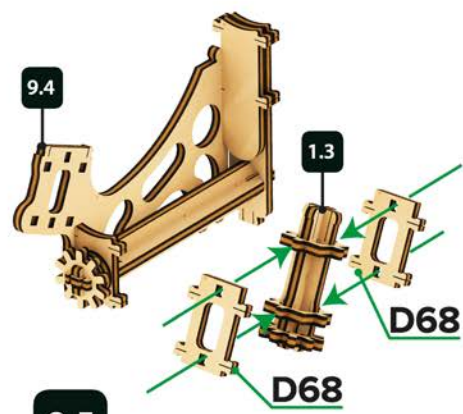

9.5

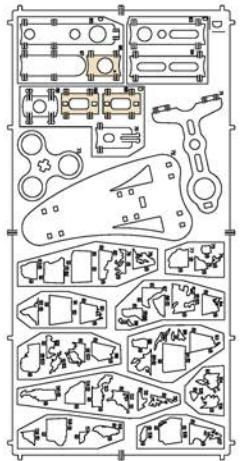
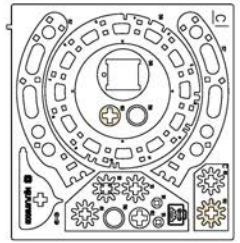



MR.
PLAY
WOOD

GIFT FOR
GIFTED

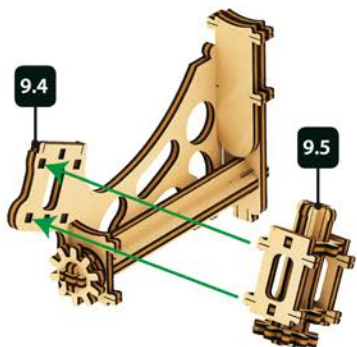

9.6

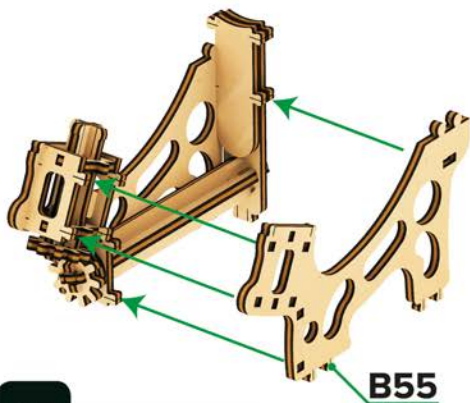

9.7

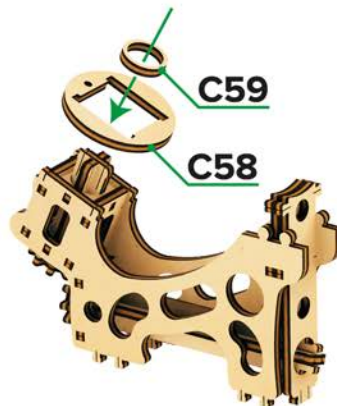

9.8



9.9

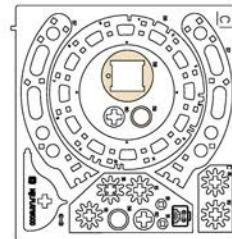



MR.
PLAY
WOOD

GIFT FOR
GIFTED

9.10



9.11



9.12

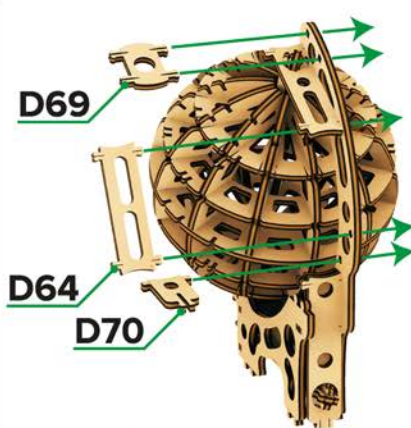

9.13

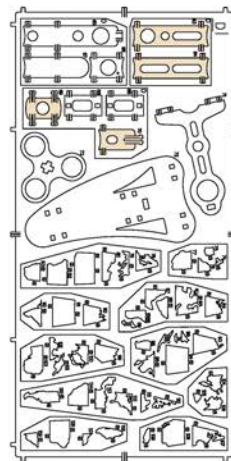
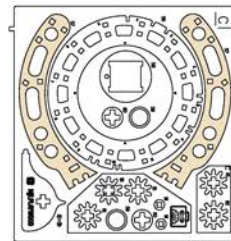
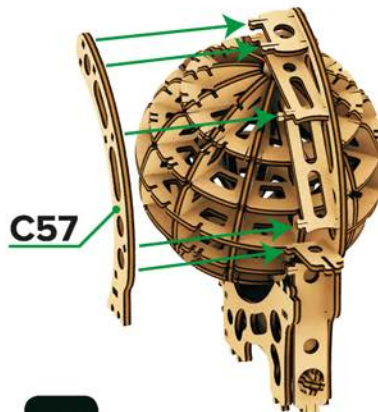



9.14



9.15

D72

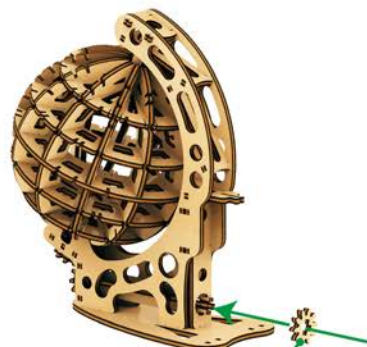

9.16

C61

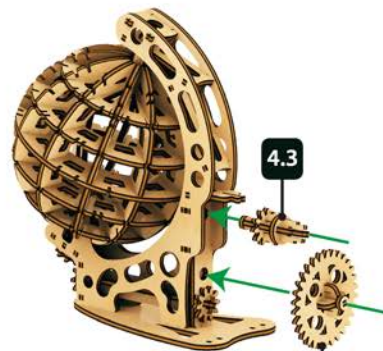

9.17

4.3

3.3

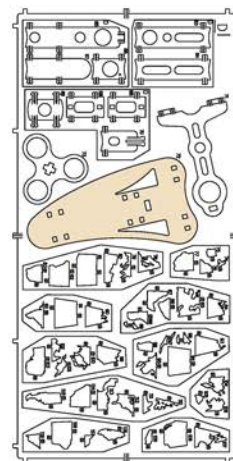
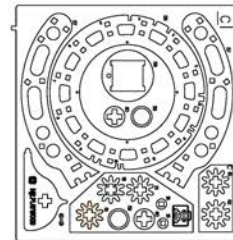



MR.
PLAY
WOOD

GIFT FOR
GIFTED

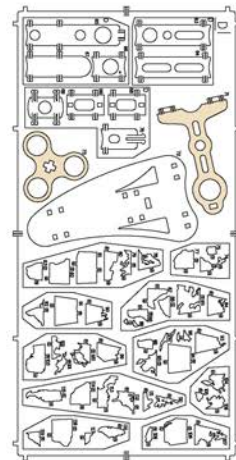
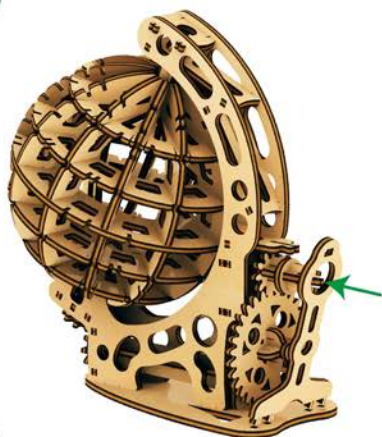
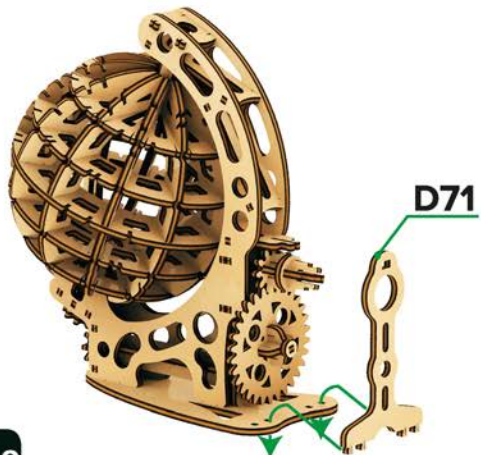

MR. PLAY WOOD

GIFT FOR
GIFTED

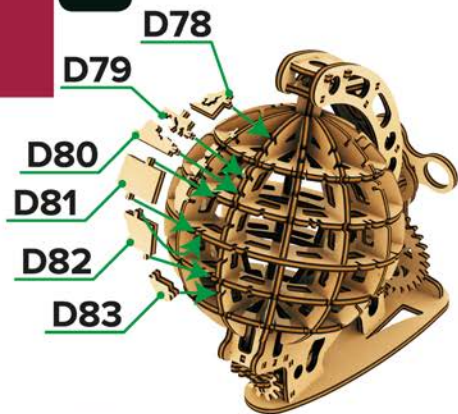
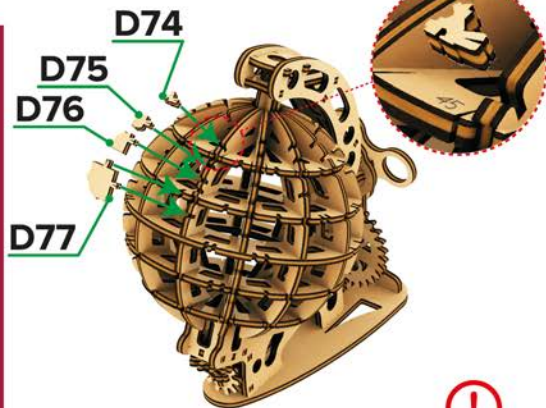

10.2

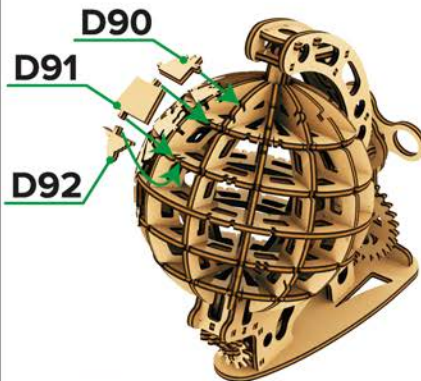
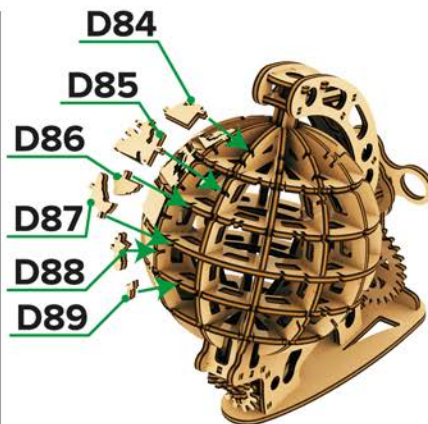

10.4

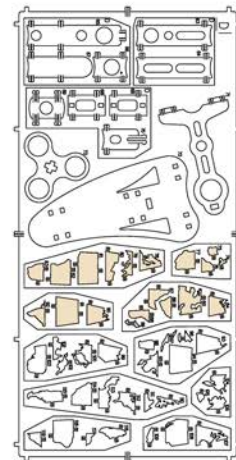

**MR.
PLAY
WOOD**

GIFT FOR
GIFTED

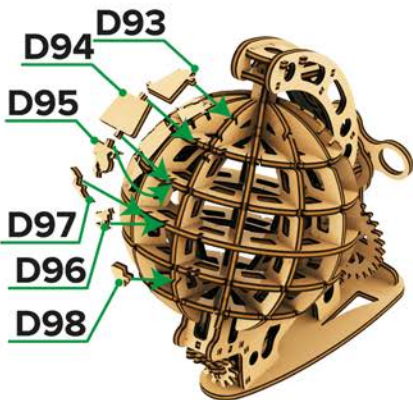

10.5

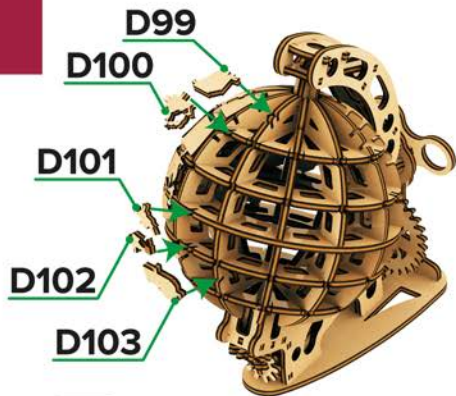

10.6



10.7



10.8

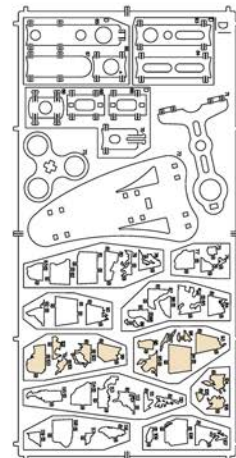



MR.
PLAY
WOOD

GIFT FOR
GIFTED



10.9



10.10

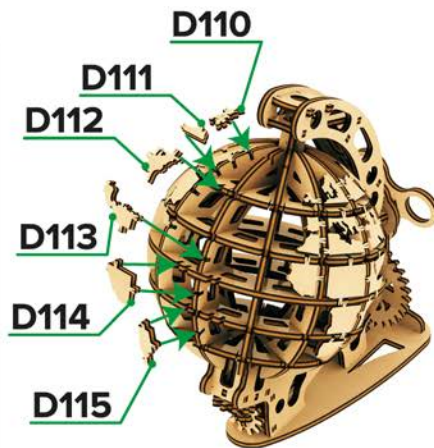

10.11

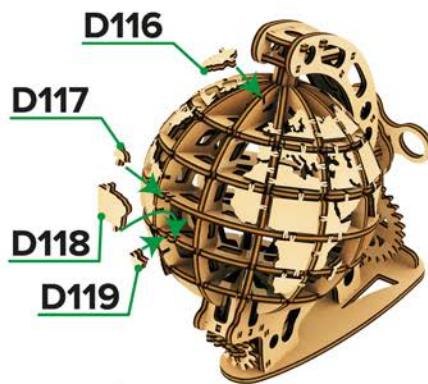

10.12

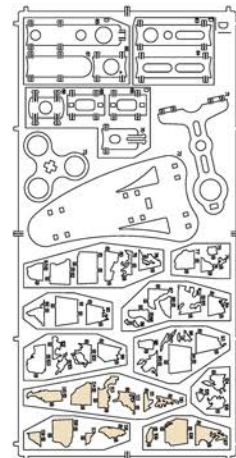



MR.
PLAY
WOOD

GIFT FOR
GIFTED



10.13



10.15



10.14



10.16

